



Slide Rail

THK General Catalog

A Product Descriptions

Features and Types	A13-2
Features of the Slide Rail	A13-2
• Structure and Features	A13-2
Slide Rail Types	A13-3
• Types and Features	A13-3
Classification Table for Slide Rails.....	A13-12

Dimensional Drawing, Dimensional Table

Model FBL 27S	A13-14
Model FBL 27S-P14	A13-15
Model FBL 35S	A13-16
Model FBL 35S-P13	A13-17
Model FBL 35S-P14	A13-18
Model FBL 35M	A13-19
Model FBL 35J	A13-20
Model FBL 35B	A13-21
Model FBL 27D	A13-22
Model FBL 35N	A13-24
Model FBL 35N-P16	A13-25
Model FBL 35G-P13	A13-26
Model FBL 35G-P14	A13-27
Model FBL 35D	A13-28
Model FBL 51H	A13-29
Model FBL 51H-P13	A13-30
Model FBL 51H-P14	A13-31
Model FBL 35K	A13-32
Model FBL 56H	A13-33
Model FBL 56H-P13	A13-34
Model FBL 56H-P14	A13-35
Model FBL 35F	A13-36
Model E36RS	A13-37
Model E15	A13-38
Model E20	A13-39
Model D20	A13-40

Point of Design	A13-41
------------------------------	--------

Model No.	A13-43
• Model Number Coding	A13-43

Precautions on Use	A13-44
---------------------------------	--------

B Support Book (Separate)

Features and Types	B13-2
Features of the Slide Rail	B13-2
• Structure and Features	B13-2
Slide Rail Types	B13-3
• Types and Features	B13-3
Classification Table for Slide Rails.....	B13-12

Mounting Procedure	B13-14
Mounting the Slide Rail.....	B13-14

Model No.	B13-17
• Model Number Coding	B13-17

Precautions on Use	B13-18
---------------------------------	--------

Features of the Slide Rail

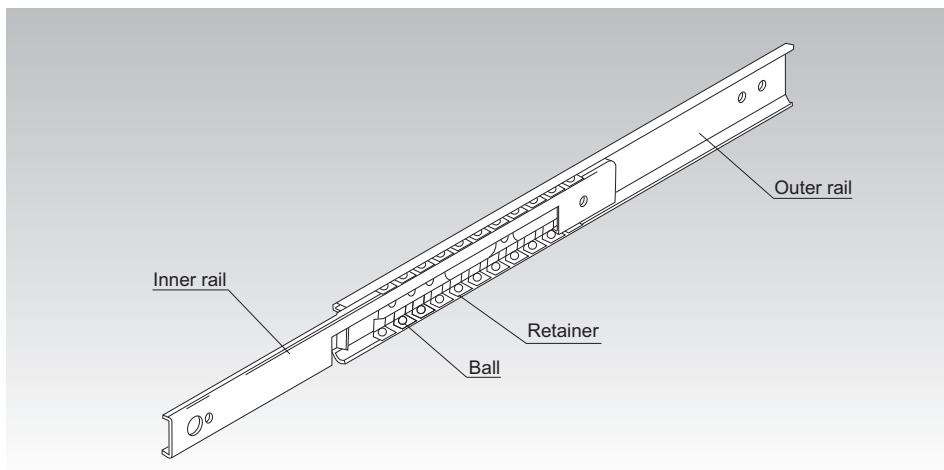

Fig.1 Structure of Slide Rail Model FBL

Structure and Features

Slide rails are low-price finite linear guides made out of precision roll-formed steel plates. They are suitable as linear motion guides for various applications because they are thin, compact, and easy to mount. Slide rails can be used in a wide range of applications such as photocopiers, measuring instruments, telecommunications equipment, medical equipment, automatic vending machines, and various types of office equipment.

The Model FBL slide rail has two rows of ball bearings placed between an inner rail and an outer rail that have been roll-formed out of steel plates. The ball bearings are evenly spaced by a precisely press-molded retainer, eliminating friction between the bearings and achieving a smooth sliding mechanism.

[Allows Easy Installation]

Simple to mount on the mounting surface. Since retainers hold the bearings, they do not fall out even if the inner rail is removed.

[Thin and Compact]

The thin cross section of the Model FBL slide rail means it can be installed in small spaces, and it is suitable for places where space saving is required.

[High Corrosion Resistance]

The Model FBL slide rail is treated with zinc plating, and models E and D are treated with a white anodized aluminum coating, making them highly corrosion-resistant.

Slide Rail Types

Types and Features

[Single Slides for Light Load]

Model FBL 27S

The most compact slide rail.

Specification Table⇒ **A** 13-14

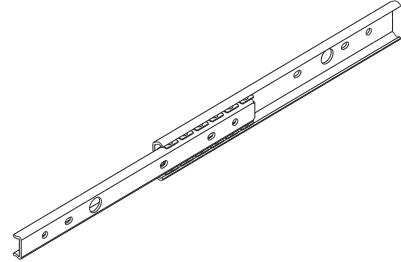

Model FBL 27S

Model FBL 27S-P14

The Model FBL 27S features a removable inner rail. When retracted, the inner rail can be automatically unlocked by pushing it further into the outer rail.

Specification Table⇒ **A** 13-15

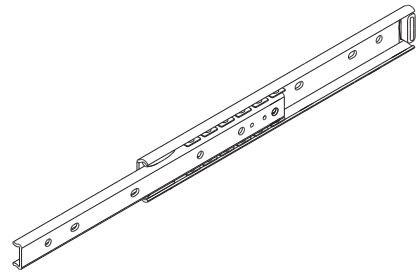

Model FBL 27S-P14

Model FBL 35S

A single slide type of slide rail with the most fundamental shape.

Specification Table⇒ **A** 13-16

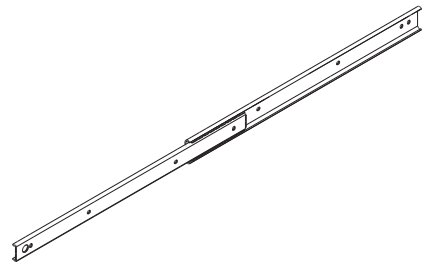

Model FBL 35S

Model FBL 35S-P13

The Model FBL 35S features a removable inner rail. When retracted, it can be unlocked manually.

Specification Table⇒ **A13-17**

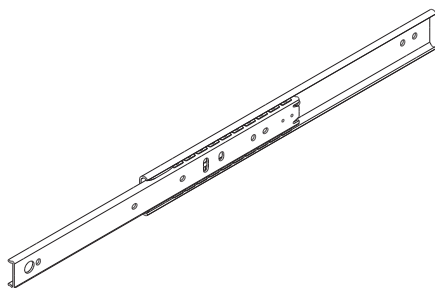

Model FBL 35S-P13

Model FBL 35S-P14

The Model FBL 35S features a removable inner rail. When retracted, the inner rail can be automatically unlocked by pushing it further into the outer rail.

Specification Table⇒ **A13-18**

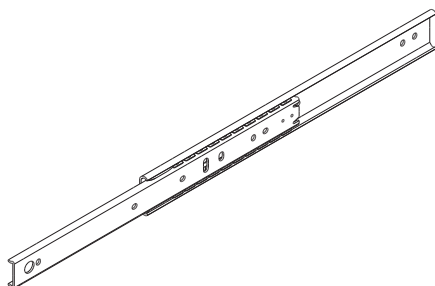

Model FBL 35S-P14

Model FBL 35M

The Model FBL 35S features a removable inner rail. The slide rail is designed to stop by frictional resistance when it is fully opened. Remove the inner rail by applying more force. (Includes a brake stop)

Specification Table⇒ **A13-19**

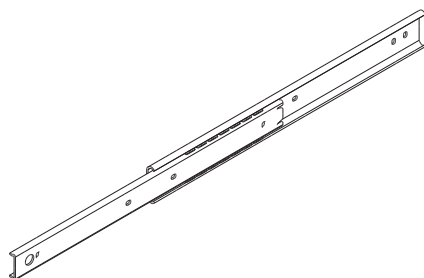

Model FBL 35M

Features and Types

Slide Rail Types

Model FBL 35J

The Model FBL 35M with additional lead ball that serves as a guide when the inner rail is inserted.

Specification Table⇒ **A** 13-20

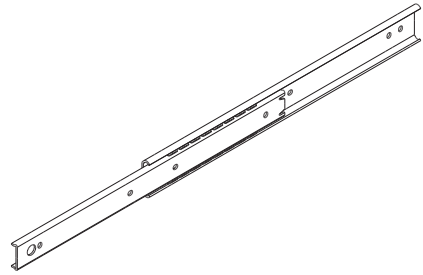

Model FBL 35J

Model FBL 35B

The Model FBL 35M with additional mounting bracket.

Specification Table⇒ **A** 13-21

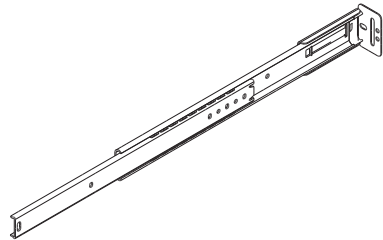

Model FBL 35B

[Double Slides for Light Load]

Model FBL 27D

A double slide with an additional Model FBL 27S attached on the rear side of the inner rail. Widely used in many types of OA equipment.

Specification Table⇒ **A13-22**

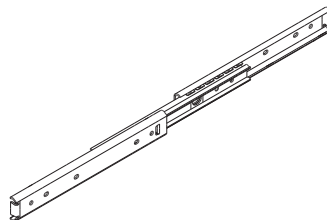

Model FBL 27D

Model FBL 35N

This is a three-rail double slide that allows a long stroke in a small space.

This product uses a plate thickness of 1.2 mm and a light-load double slide rail to achieve weight reduction.

Specification Table⇒ **A13-24**



Model FBL 35N

Model FBL 35N-P16

This is a three-rail double slide that allows a long stroke in a small space. It uses a plate thickness of 1.2 mm and a light-load double slide rail to achieve weight reduction. The inner rail can be pulled out, and it can be reinserted smoothly without the need for a release operation.

Specification Table⇒ **A13-25**

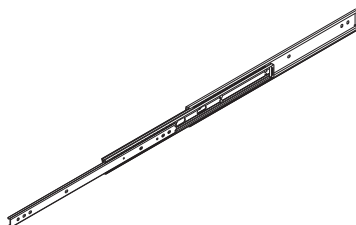

Model FBL 35N-P16

Features and Types

Slide Rail Types

[Double Slides for Medium Load]

Model FBL 35G-P13

A double slide with an additional Model FBL 35S attached on the front side. The drawer rail can be pulled out, and it can be manually unlocked when retracted. It is also equipped with a useful locking mechanism that engages when the slide rail is fully opened.

Specification Table⇒ **A** 13-26

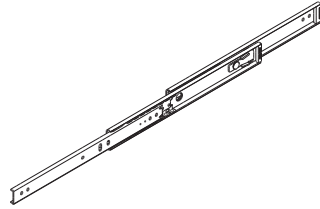

Model FBL 35G-P13

Model FBL 35G-P14

A double slide with an additional Model FBL 35S attached on the front side. The drawer rail can be pulled out, and it can be automatically unlocked by pushing it further into the outer rail. It is also equipped with a useful locking mechanism that engages when the slide rail is fully opened.

Specification Table⇒ **A** 13-27

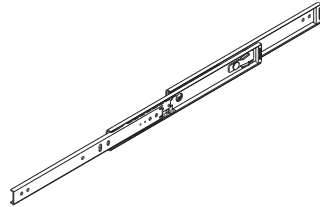

Model FBL 35G-P14

Model FBL 35D

A double slide with an additional Model FBL 35S attached on the rear side of the inner rail. Widely used in a number of different industries.

Specification Table⇒ **A** 13-28

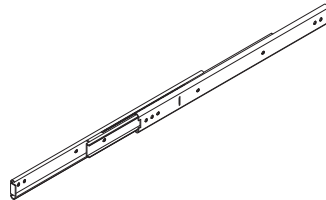

Model FBL 35D

Model FBL 51H

A three-rail double slide that allows a long stroke. A thin model that can be used in small spaces, even with large working loads.

Specification Table⇒ **A13-29**

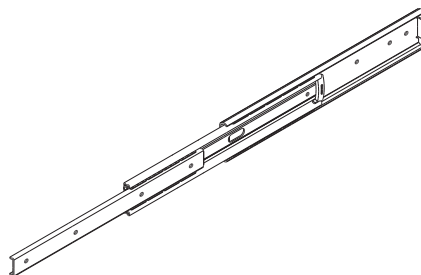

Model FBL 51H

Model FBL 51H-P13

A three-rail double slide that allows a long stroke. A thin model that can be used in small spaces, even with large working loads. The inner rail can be pulled out, and locked states caused by the disconnection spring can be manually released when retracted. It is also equipped with a useful locking mechanism that engages when the slide rail is fully opened.

Specification Table⇒ **A13-30**

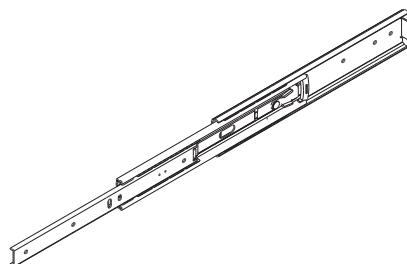

Model FBL 51H-P13

Model FBL 51H-P14

A three-rail double slide that allows a long stroke. A thin model that can be used in small spaces, even with large working loads. The inner rail can be pulled out, and it can be automatically unlocked by pushing it further into the outer rail.

Specification Table⇒ **A13-31**

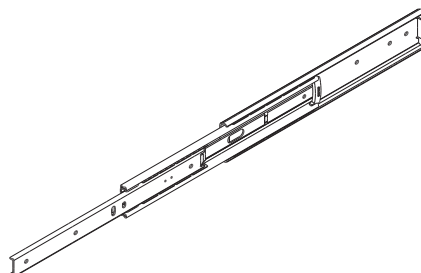

Model FBL 51H-P14

[Double Slides for Heavy Load]

Model FBL 35K

A double slide combining four Model FBL 35S units. It features the largest allowable load among all models, making it suitable for opening/closing heavy objects.

Specification Table⇒ **A 13-32**

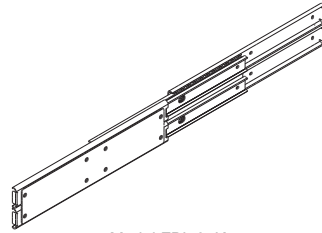

Model FBL 35K

Model FBL 56H

Three-rail double slide with a large allowable load. Widely used in many types of office furniture.

Specification Table⇒ **A 13-33**

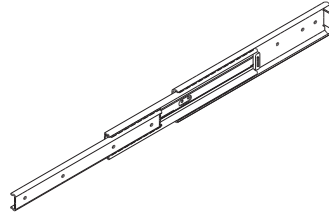

Model FBL 56H

Model FBL 56H-P13

Three-rail double slide with a large allowable load. The inner rail can be pulled out, and it can be manually unlocked when retracted. It is also equipped with a useful locking mechanism that engages when the slide rail is fully opened.

Specification Table⇒ **A 13-34**

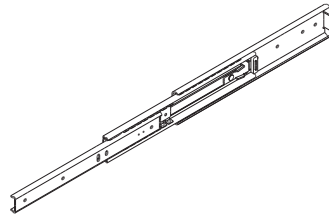

Model FBL 56H-P13

Model FBL 56H-P14

Three-rail double slide with a large allowable load. The inner rail can be pulled out, and it can be automatically unlocked by pushing it further into the outer rail.

Specification Table⇒ **A 13-35**

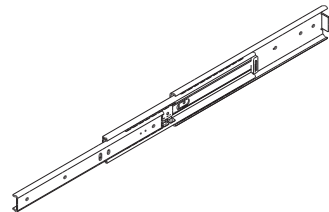

Model FBL 56H-P14

[Linear Type Slides]

Light Load Type Model FBL 35F

Linear-type slide suitable for limited straight motion, featuring a flange for easy mounting.

Specification Table⇒ **A13-36**

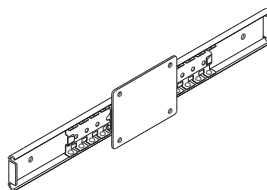

Light Load Type Model FBL 35F

[Wheel-type Linear Slide]

Model E36RS

A linear slide that features wear-resistant resin bearings.

Specification Table⇒ **A13-37**

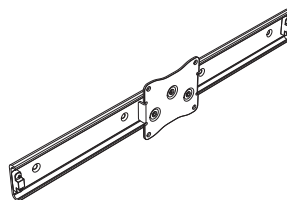

Model E36RS

[Aluminum Alloy Slide Rail]**Light Load Type Model E15**

A compact and lightweight single slide from the aluminum alloy series. Suitable for locations within magnetic fields, locations requiring rust-resistant materials, and locations where appearance is a factor.

Specification Table⇒ **A13-38**

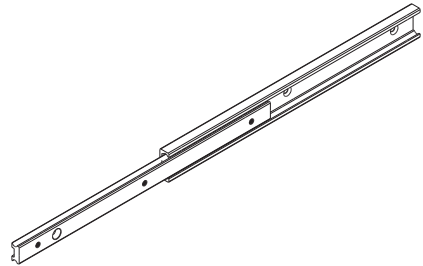

Light Load Type Model E15

Light Load Type Model E20

A basic single slide from the aluminum alloy series. Suitable for locations within magnetic fields, locations requiring rust-resistant materials, and locations where appearance is a factor.

Specification Table⇒ **A13-39**

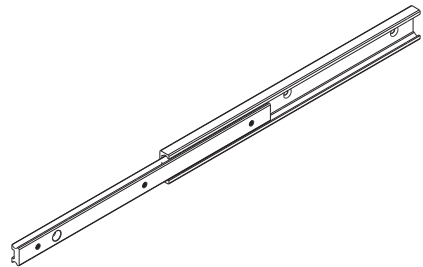

Light Load Type Model E20

Light Load Type Model D20

The most compact and lightweight double slide in the aluminum alloy series. Suitable for locations within magnetic fields, locations requiring rust-resistant materials, and locations where appearance is a factor.

Specification Table⇒ **A13-40**

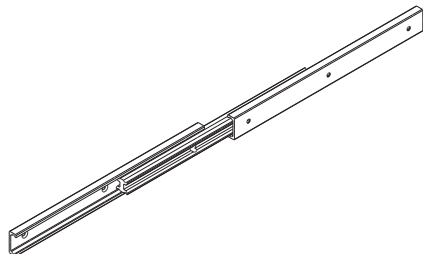

Light Load Type Model D20

Classification Table for Slide Rails

Slide Rail

Single Slide

For Light Load

Model FBL27S

Model FBL27S-P14

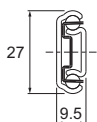

Model FBL35J

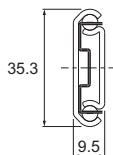

Model FBL35S

Model FBL35S-P13

Model FBL35S-P14

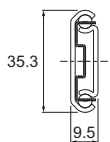

Model FBL35B

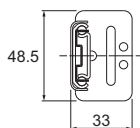

Model E15
(Made of Aluminum)

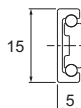

Model FBL35M

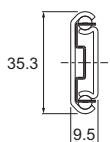

Model E20
(Made of Aluminum)

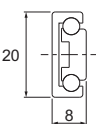

Double Slide

For Light Load

Model FBL27D

Model D20
(Made of aluminum)

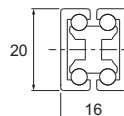
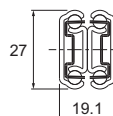

Model FBL35N

Model FBL35N-P16

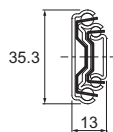

For Medium Load

Model FBL35G-P13

Model FBL51H

Model FBL35G-P14

Model FBL51H-P13

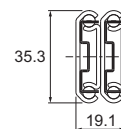

Model FBL51H-P14

Model FBL35D

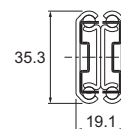
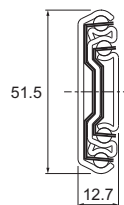

Features and Types

Classification Table for Slide Rails

Linear Type Slide

For Heavy Load

Model FBL35K

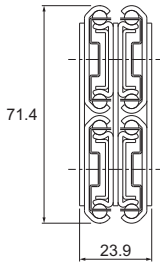

Model FBL56H

Model FBL56H-P13

Model FBL56H-P14

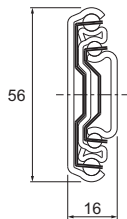

For Light Load

Model FBL35F

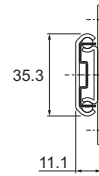

Wheel Type

Model E36RS (Aluminum Outer Rail)

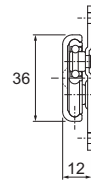

Slide Rail

Model FBL 27S

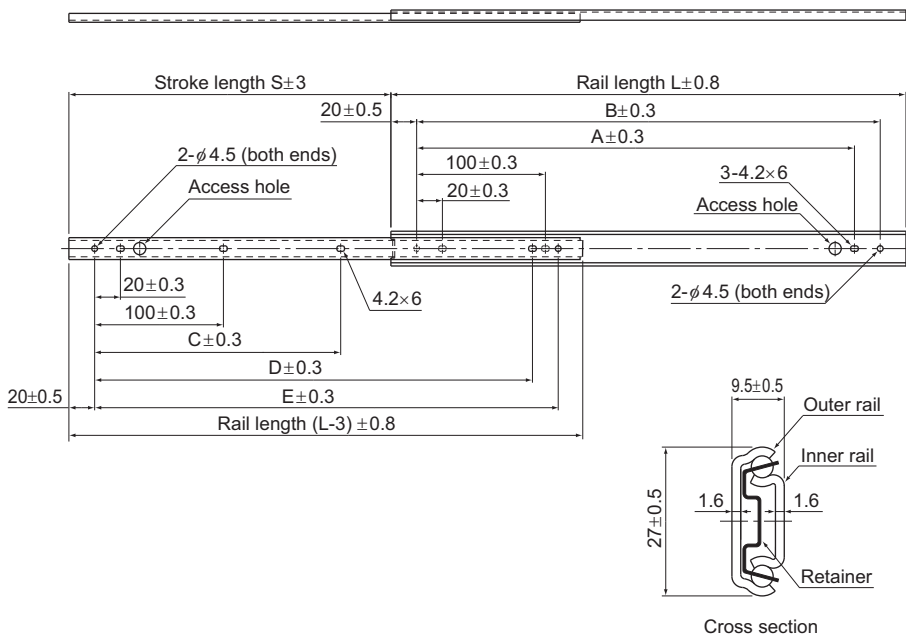

Unit: mm

Rail length L (± 0.8)	Stroke S (± 3)	Mounting hole dimensions					Mounting hole		Permissible load N/pair	Mass kg/pair
		A	B	C	D	E	Inner rail	Outer rail		
200	135	140	160	—	140	160	5	5	260	0.32
250	185	190	210	150	190	210	6	5	240	0.4
300	222	240	260	190	240	260	6	5	240	0.48
350	260	290	310	225	290	310	6	5	230	0.56
400	297	340	360	265	340	360	6	5	210	0.64
450	334	390	410	300	390	410	6	5	200	0.72
500	371	440	460	337	440	460	6	5	180	0.8

Note: The Permissible Load and Mass each indicate when used as a pair of 2 units.

Model number coding

FBL27S +300L

Model number Overall rail length (mm)

Model FBL 27S-P14

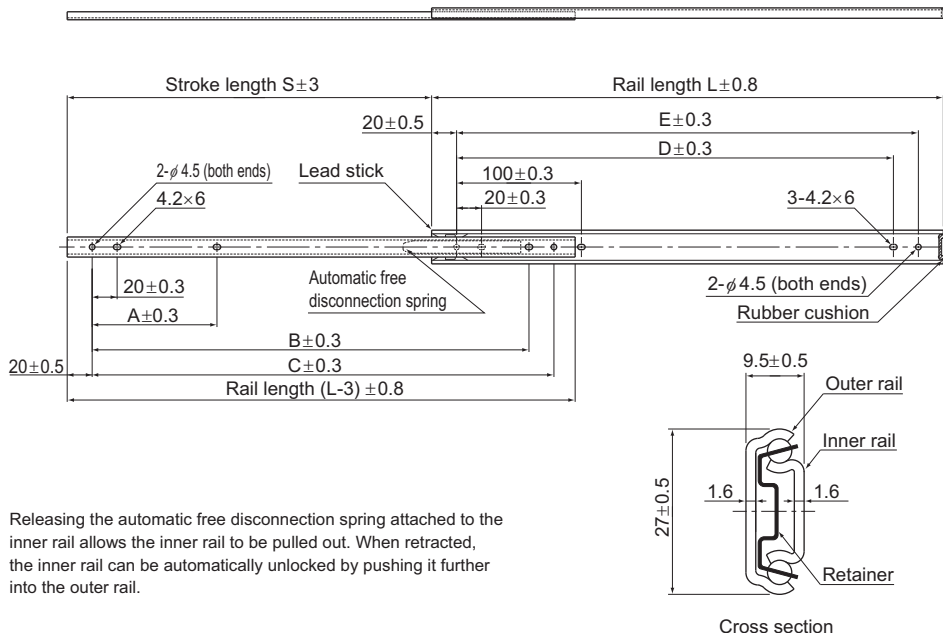

Releasing the automatic free disconnection spring attached to the inner rail allows the inner rail to be pulled out. When retracted, the inner rail can be automatically unlocked by pushing it further into the outer rail.

Unit: mm

Rail length L (± 0.8)	Stroke S (± 3)	Mounting hole dimensions					Mounting hole		Permissible load N/pair	Mass kg/pair
		A	B	C	D	E	Inner rail	Outer rail		
200	116	65	—	170	140	160	4	5	260	0.32
250	152	100	—	210	190	210	4	5	240	0.4
300	202	100	—	260	240	260	4	5	240	0.48
350	251	100	—	310	290	310	4	5	230	0.56
400	297	100	—	360	340	360	4	5	210	0.64
450	332	100	390	410	390	410	5	5	210	0.72
500	371	100	440	460	440	460	5	5	200	0.8
550	407	100	490	510	490	510	5	5	180	0.8

Note: The Permissible Load and Mass each indicate when used as a pair of 2 units.

Model number coding

FBL27S-P14 +500L

Model number

Overall rail length (mm)

Model FBL 35S

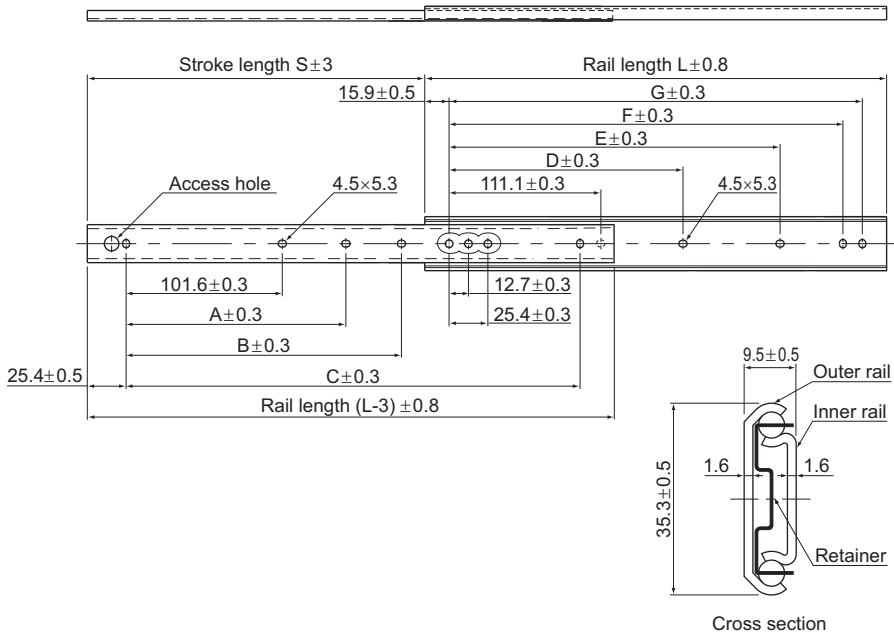

Unit: mm

Rail length L (±0.8)	Stroke S (±3)	Mounting hole dimensions							Mounting hole		Permissible load N/pair	Mass kg/pair
		A	B	C	D	E	F	G	Inner rail	Outer rail		
305	229	—	152.4	254	—	149.2	260.3	273	4	7	490	0.6
356	279	—	203.2	304.8	—	200	311.1	323.8	4	7	400	0.7
406	305	—	254	355.6	—	250.8	361.9	374.6	4	7	390	0.8
457	330	203.2	304.8	406.4	212.7	301.6	412.7	425.4	5	8	380	0.9
508	381	228.6	355.6	457.2	238.1	352.4	463.5	476.2	5	8	330	1
559	406	254	406.4	508	263.5	403.2	514.3	527	5	8	320	1.1
610	432	279.4	457.2	558.8	288.9	454	565.1	577.8	5	8	310	1.2
660	483	304.8	508	609.6	314.3	504.8	615.9	628.6	5	8	280	1.3
711	508	330.2	558.8	660.4	339.7	555.6	666.7	679.4	5	8	270	1.4

Note: The Permissible Load and Mass each indicate when used as a pair of 2 units.

Model number coding

FBL35S +457L

Model number Overall rail length (mm)

Model FBL 35S-P13

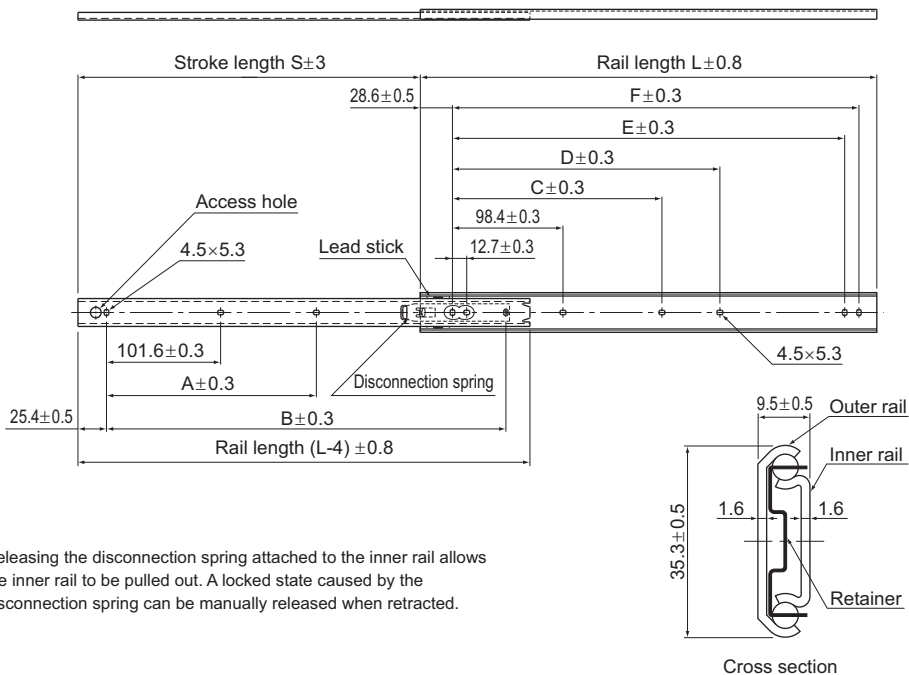

Releasing the disconnection spring attached to the inner rail allows the inner rail to be pulled out. A locked state caused by the disconnection spring can be manually released when retracted.

Unit: mm

Rail length L (±0.8)	Stroke S (±3)	Mounting hole dimensions						Mounting hole		Permissible load N/pair	Mass kg/pair
		A	B	C	D	E	F	Inner rail	Outer rail		
305	224	152.4	—	136.5	—	247.6	260.3	3	6	490	0.6
356	275	203.2	—	187.3	—	298.4	311.1	3	6	400	0.72
406	315	254	—	238.1	—	349.2	361.9	3	6	390	0.84
457	330	203.2	406.4	200	288.9	400	412.7	4	7	380	0.96
508	381	228.6	457.2	225.4	339.7	450.8	463.5	4	7	330	1.04
559	406	254	508	250.8	390.5	501.6	514.3	4	7	320	1.16
610	432	279.4	558.8	276.2	441.3	552.4	565.1	4	7	310	1.24
660	483	304.8	609.6	301.6	492.1	603.2	615.9	4	7	280	1.36
711	493	330.2	660.4	327	542.9	654	666.7	4	7	270	1.48

Note: The Permissible Load and Mass each indicate when used as a pair of 2 units.

Model number coding

FBL35S-P13 +559L

Model number

Overall rail length (mm)

Model FBL 35S-P14

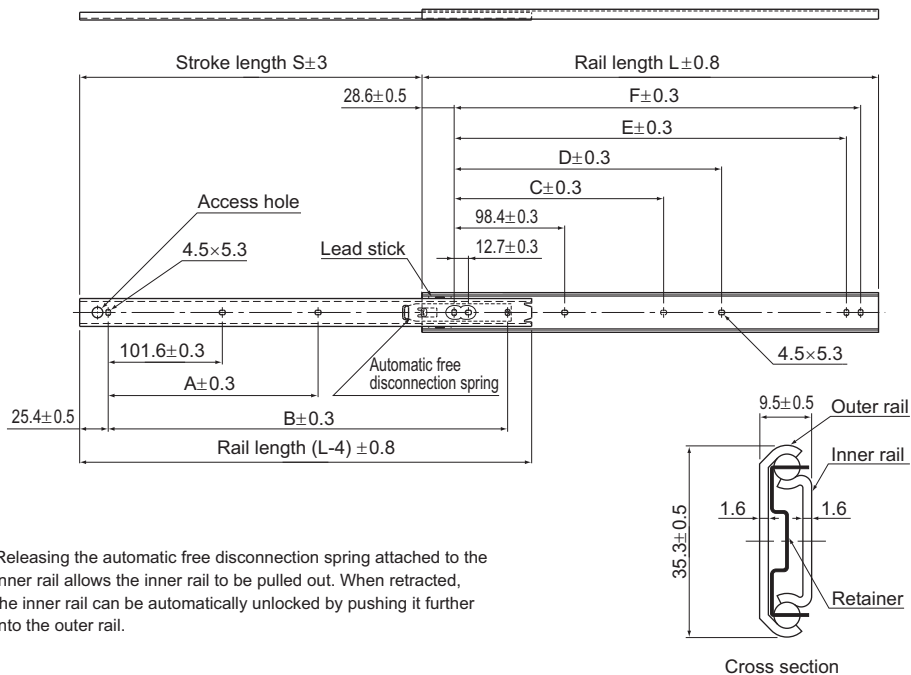

Releasing the automatic free disconnection spring attached to the inner rail allows the inner rail to be pulled out. When retracted, the inner rail can be automatically unlocked by pushing it further into the outer rail.

Unit: mm

Rail length L (±0.8)	Stroke S (±3)	Mounting hole dimensions						Mounting hole		Permissible load N/pair	Mass kg/pair
		A	B	C	D	E	F	Inner rail	Outer rail		
305	224	152.4	—	136.5	—	247.6	260.3	3	6	490	0.6
356	275	203.2	—	187.3	—	298.4	311.1	3	6	400	0.72
406	315	254	—	238.1	—	349.2	361.9	3	6	390	0.84
457	330	203.2	406.4	200	288.9	400	412.7	4	7	380	0.96
508	381	228.6	457.2	225.4	339.7	450.8	463.5	4	7	330	1.04
559	406	254	508	250.8	390.5	501.6	514.3	4	7	320	1.16
610	432	279.4	558.8	276.2	441.3	552.4	565.1	4	7	310	1.24
660	483	304.8	609.6	301.6	492.1	603.2	615.9	4	7	280	1.36
711	493	330.2	660.4	327	542.9	654	666.7	4	7	270	1.48

Note: The Permissible Load and Mass each indicate when used as a pair of 2 units.

Model number coding

FBL35S-P14 +559L

Model number

Overall rail length (mm)

Model FBL 35M

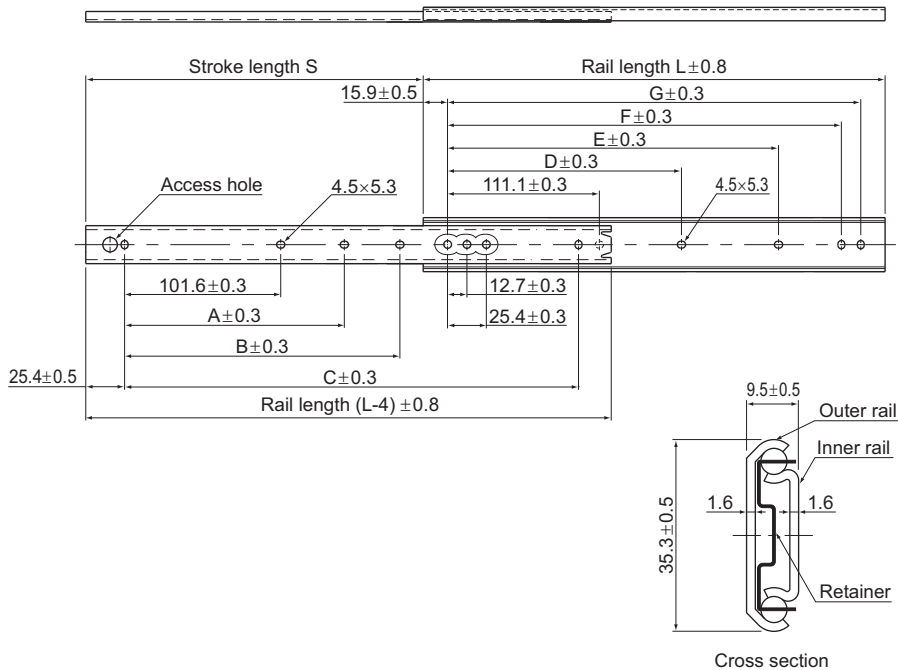

Cross section

Unit: mm

Rail length L (±0.8)	Stroke S	Mounting hole dimensions							Mounting hole		Permissible load N/pair	Mass kg/pair
		A	B	C	D	E	F	G	Inner rail	Outer rail		
305	229	—	152.4	254	—	149.2	260.3	273	4	7	490	0.6
356	279	—	203.2	304.8	—	200	311.1	323.8	4	7	400	0.7
406	305	—	254	355.6	—	250.8	361.9	374.6	4	7	390	0.8
457	330	203.2	304.8	406.4	212.7	301.6	412.7	425.4	5	8	380	0.9
508	381	228.6	355.6	457.2	238.1	352.4	463.5	476.2	5	8	330	1
559	406	254	406.4	508	263.5	403.2	514.3	527	5	8	320	1.1
610	432	279.4	457.2	558.8	288.9	454	565.1	577.8	5	8	310	1.2
660	483	304.8	508	609.6	314.3	504.8	615.9	628.6	5	8	280	1.3
711	508	330.2	558.8	660.4	339.7	555.6	666.7	679.4	5	8	270	1.4

Note: The Permissible Load and Mass each indicate when used as a pair of 2 units.

Model number coding

FBL35M +406L

Model number Overall rail length (mm)

Model FBL 35J

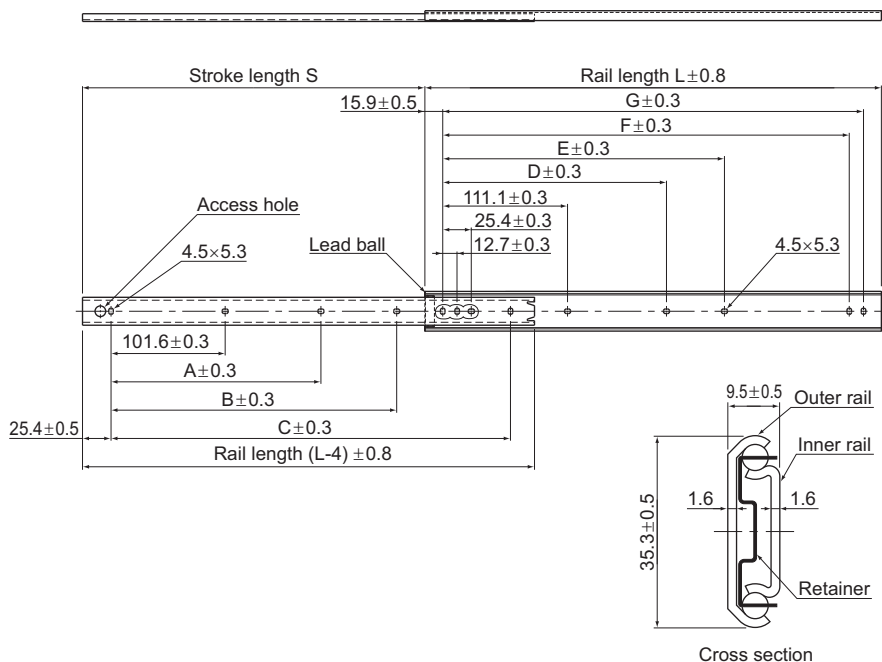

Unit: mm

Rail length L (±0.8)	Stroke S	Mounting hole dimensions							Mounting hole		Permissible load N/pair	Mass kg/pair
		A	B	C	D	E	F	G	Inner rail	Outer rail		
305	229	—	152.4	254	—	149.2	260.3	273	4	7	490	0.6
356	279	—	203.2	304.8	—	200	311.1	323.8	4	7	400	0.7
406	305	—	254	355.6	—	250.8	361.9	374.6	4	7	390	0.8
457	330	203.2	304.8	406.4	212.7	301.6	412.7	425.4	5	8	380	0.9
508	381	228.6	355.6	457.2	238.1	352.4	463.5	476.2	5	8	330	1
559	406	254	406.4	508	263.5	403.2	514.3	527	5	8	320	1.1
610	432	279.4	457.2	558.8	288.9	454	565.1	577.8	5	8	310	1.2
660	483	304.8	508	609.6	314.3	504.8	615.9	628.6	5	8	280	1.3
711	508	330.2	558.8	660.4	339.7	555.6	666.7	679.4	5	8	270	1.4

Note: The Permissible Load and Mass each indicate when used as a pair of 2 units.

Model number coding

FBL35J +660L

Model number Overall rail length (mm)

Model FBL 35B

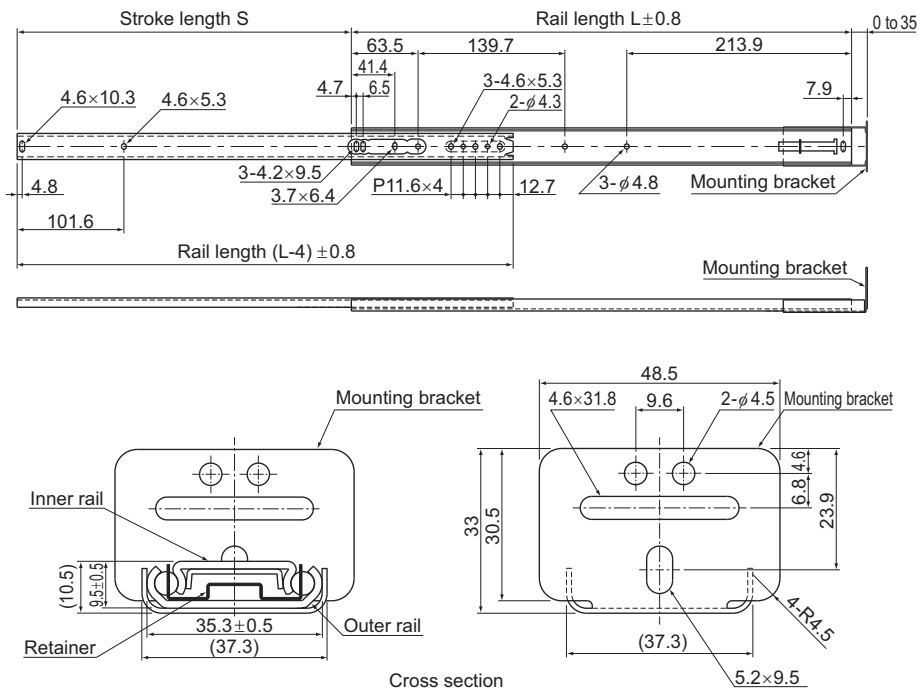

Unit: mm

Rail length L (±0.8)	Stroke S	Mounting hole		Permissible load N/pair	Mass kg/pair
		Inner rail	Outer rail		
324	216	7	7	115	0.8
375	267	7	7	105	0.92
425	305	7	7	100	1
476	318	7	7	90	1.12
527	368	7	7	83	1.24
578	419	7	7	73	1.32
629	445	7	7	66	1.44
679	495	7	7	61	1.6

Note: The Permissible Load and Mass each indicate when used as a pair of 2 units.

Model number coding

FBL35B +375L

Model number Overall rail length (mm)

Model FBL 27D

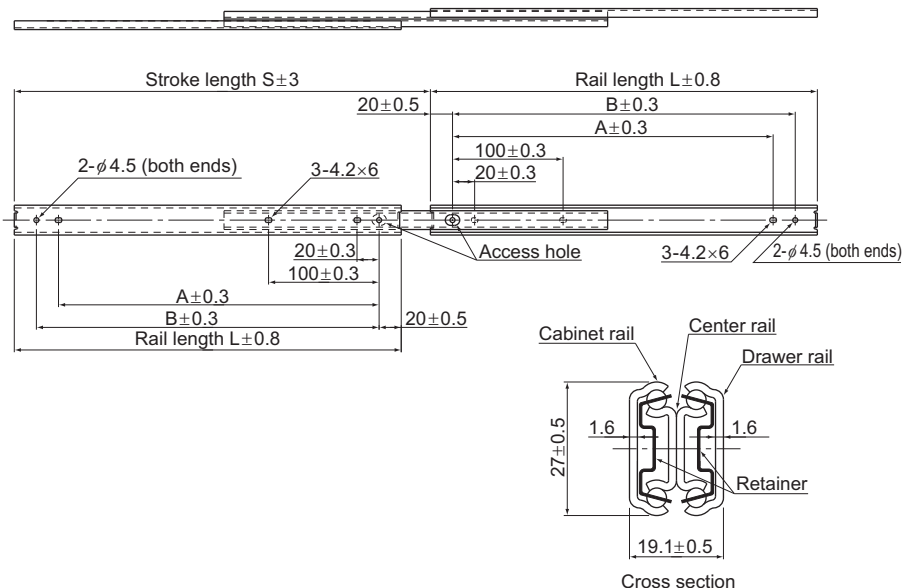

Unit: mm

Rail length L (±0.8)	Stroke S (±3)	Mounting hole dimensions		Mounting hole		Permissible load N/pair	Mass kg/pair
		A	B	Drawer rail	Cabinet rail		
200	229	140	160	5	5	370	0.64
250	276	190	210	5	5	360	0.8
300	327	240	260	5	5	350	0.96
350	376	290	310	5	5	330	1.12
400	426	340	360	5	5	310	1.28
450	475	390	410	5	5	290	1.46
500	524	440	460	5	5	280	1.6

Note: The Permissible Load and Mass each indicate when used as a pair of 2 units.

Model number coding

FBL27D +200L

Model number Overall rail length (mm)

Model FBL 35N

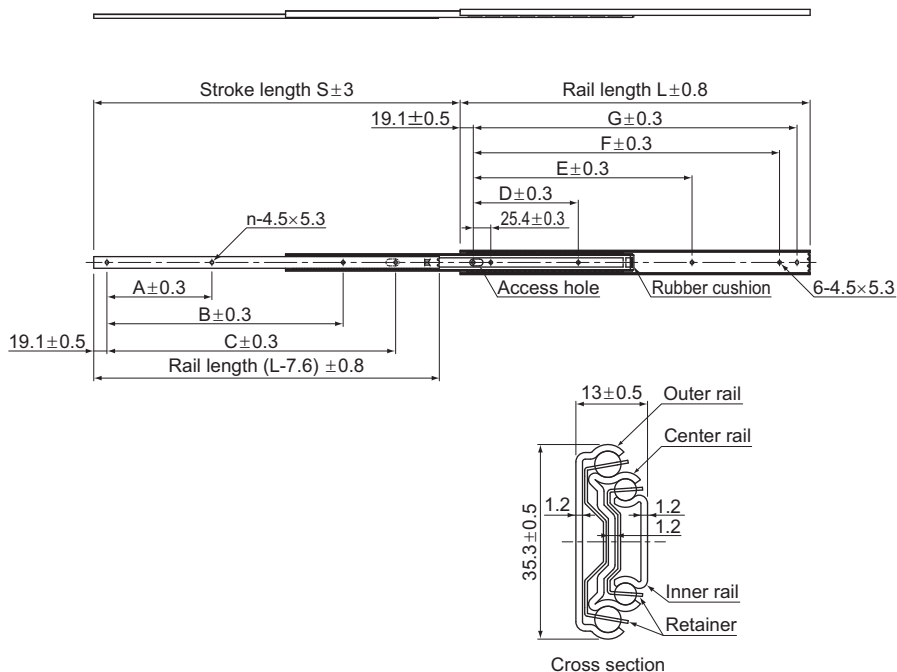

Unit: mm

Rail length L (± 0.8)	Stroke S (± 3)	Mounting hole dimensions							Mounting hole n Inner rail	Permissible load N/pair	Mass kg/pair
		A	B	C	D	E	F	G			
254	280	76.2	154.9	180.3	76.2	139.7	190.5	215.9	4	290	0.61
305	330	76.2	154.9	231.1	76.2	190.5	241.3	266.7	4	290	0.74
356	381	127	—	266.7	88.9	215.9	292.1	317.5	3	280	0.86
406	432	152.4	—	317.5	127	241.3	342.9	368.3	3	270	0.98
457	483	177.8	—	368.3	127	292.1	393.7	419.1	3	250	1.1
508	533	152.4	342.9	419.1	152.4	317.5	444.5	469.9	4	240	1.22

Model number coding

FBL35N +508L

Model No. Overall rail length (mm)

Model FBL 35N-P16

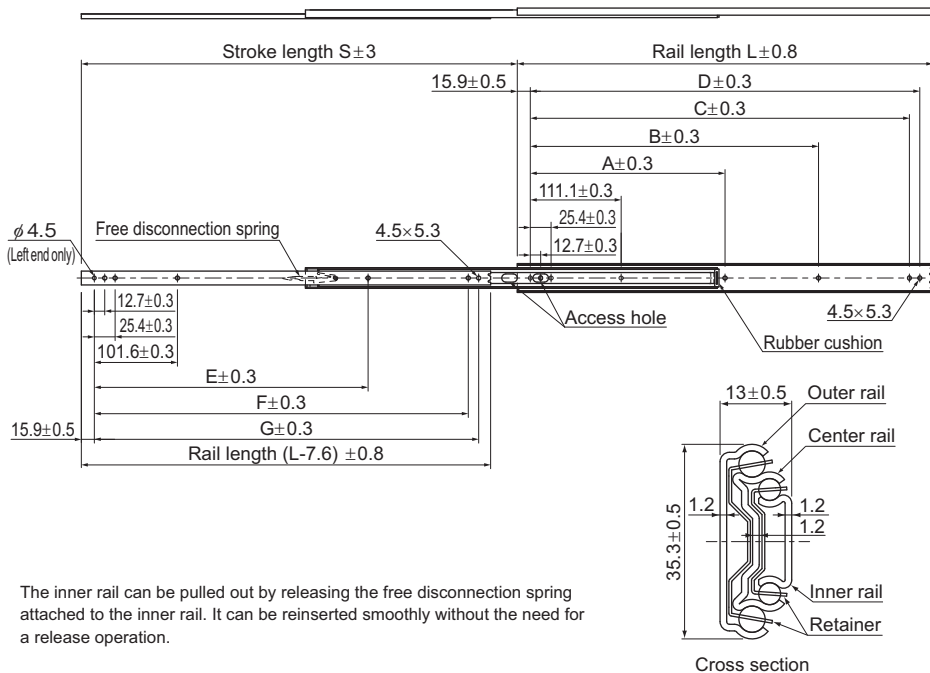

The inner rail can be pulled out by releasing the free disconnection spring attached to the inner rail. It can be reinserted smoothly without the need for a release operation.

Unit: mm

Rail length L (± 0.8)	Stroke S (± 3)	Mounting hole dimensions							Mounting hole		Permissible load N/pair	Mass kg/pair
		A	B	C	D	E	F	G	Inner rail	Outer rail		
254	280	—	—	209.5	222.2	—	203.2	215.9	6	6	290	0.61
305	330	—	149.2	260.3	273	233.1	254	266.7	7	7	290	0.74
356	381	—	200	311.1	323.8	258.5	304.8	317.5	7	7	280	0.86
406	432	—	250.8	361.9	374.6	283.9	355.6	368.3	7	7	270	0.98
457	483	212.7	301.6	412.7	425.4	309.3	406.4	419.1	7	8	250	1.1
508	533	238.1	352.4	463.5	476.2	334.7	457.2	469.9	7	8	240	1.22

Model number coding

FBL35N-P16 +508L

Model number

Overall rail length (mm)

Model FBL 35G-P13

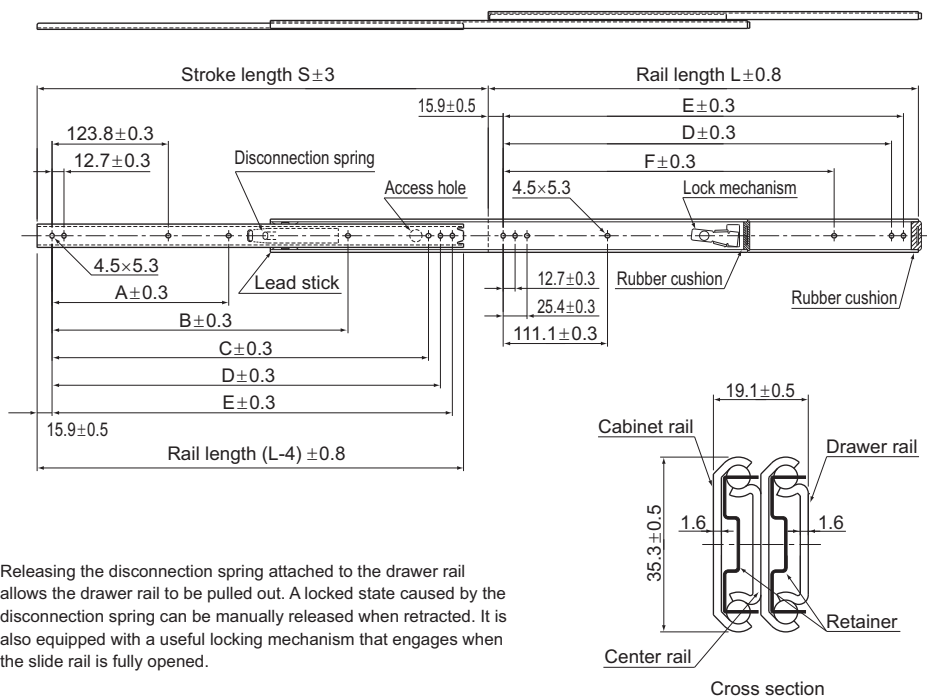

Releasing the disconnection spring attached to the drawer rail allows the drawer rail to be pulled out. A locked state caused by the disconnection spring can be manually released when retracted. It is also equipped with a useful locking mechanism that engages when the slide rail is fully opened.

Unit: mm

Rail length L (±0.8)	Stroke S (±3)	Mounting hole dimensions						Mounting hole		Permissible load N/pair	Mass kg/pair
		A	B	C	D	E	F	Drawer rail	Cabinet rail		
305	327	—	—	—	260.3	273	—	5	6	623	1.2
356	378	—	—	298.4	311.1	323.8	—	6	6	586	1.4
406	429	—	—	349.2	361.9	374.6	250.8	6	7	555	1.6
457	480	212.7	—	400	412.7	425.4	301.6	7	7	516	1.8
508	530	238.1	365.1	450.8	463.5	476.2	352.4	8	7	475	2
559	581	263.5	415.9	501.6	514.3	527	403.2	8	7	444	2.2
610	632	288.9	466.7	552.4	565.1	577.8	454	8	7	413	2.4
660	683	314.3	517.5	603.2	615.9	628.6	504.8	8	7	382	2.6
711	734	339.7	568.3	654	666.7	679.4	555.6	8	7	355	2.8

Note: The Permissible Load and Mass each indicate when used as a pair of 2 units.

Model number coding

FBL35G-P13 +356L

Model number

Overall rail length (mm)

Model FBL 35G-P14

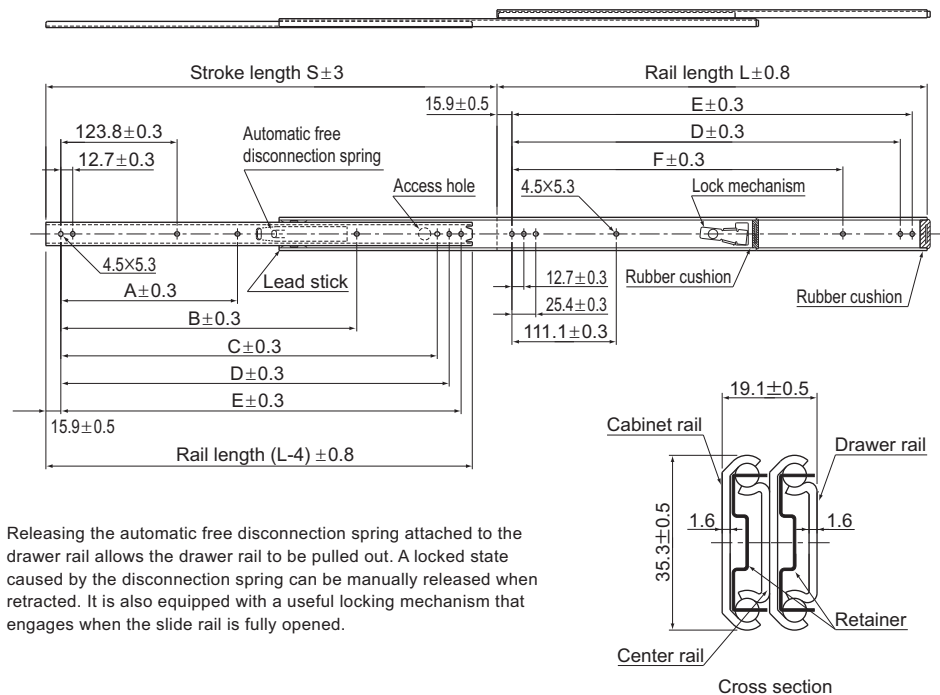

Releasing the automatic free disconnection spring attached to the drawer rail allows the drawer rail to be pulled out. A locked state caused by the disconnection spring can be manually released when retracted. It is also equipped with a useful locking mechanism that engages when the slide rail is fully opened.

Unit: mm

Rail length L (± 0.8)	Stroke S (± 0.3)	Mounting hole dimensions						Mounting hole		Permissible load N/pair	Mass kg/pair
		A	B	C	D	E	F	Drawer rail	Cabinet rail		
305	327	—	—	—	260.3	273	—	5	6	623	1.2
356	378	—	—	298.4	311.1	323.8	—	6	6	586	1.4
406	429	—	—	349.2	361.9	374.6	250.8	6	7	555	1.6
457	480	212.7	—	400	412.7	425.4	301.6	7	7	516	1.8
508	530	238.1	365.1	450.8	463.5	476.2	352.4	8	7	475	2
559	581	263.5	415.9	501.6	514.3	527	403.2	8	7	444	2.2
610	632	288.9	466.7	552.4	565.1	577.8	454	8	7	413	2.4
660	683	314.3	517.5	603.2	615.9	628.6	504.8	8	7	382	2.6
711	734	339.7	568.3	654	666.7	679.4	555.6	8	7	355	2.8

Note: The Permissible Load and Mass each indicate when used as a pair of 2 units.

Model number coding

FBL35G-P14 +610L

Model number

Overall rail length (mm)

Model FBL 35D

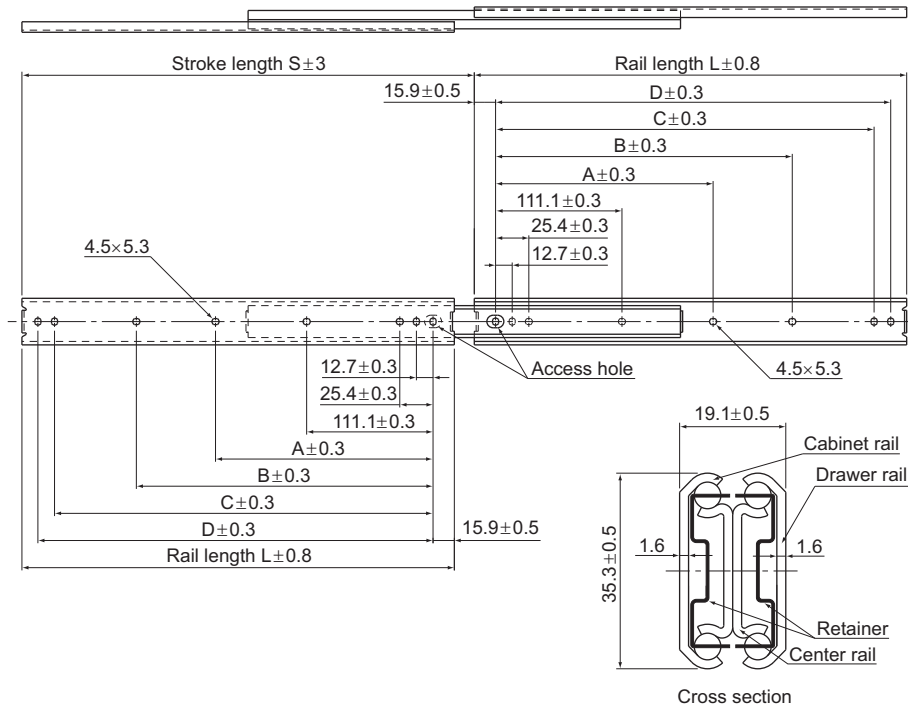

Unit: mm

Rail length L (±0.8)	Stroke S (±3)	Mounting hole dimensions				Mounting hole		Permissible load N/pair	Mass kg/pair
		A	B	C	D	Drawer rail	Cabinet rail		
305	327	—	149.2	260.3	273	7	7	588	1.28
356	378	—	200	311.1	323.8	7	7	578	1.48
406	429	—	250.8	361.9	374.6	7	7	559	1.72
457	480	212.7	301.6	412.7	425.4	8	8	549	1.96
508	530	238.1	352.4	463.5	476.2	8	8	529	2.12
559	581	263.5	403.2	514.3	527	8	8	500	2.4
610	632	288.9	454	565.1	577.8	8	8	480	2.56
660	683	314.3	504.8	615.9	628.6	8	8	461	2.8
711	734	339.7	555.6	666.7	679.4	8	8	441	3

Note: The Permissible Load and Mass each indicate when used as a pair of 2 units.

Model number coding

FBL35D +711L

Model number Overall rail length (mm)

Model FBL 51H

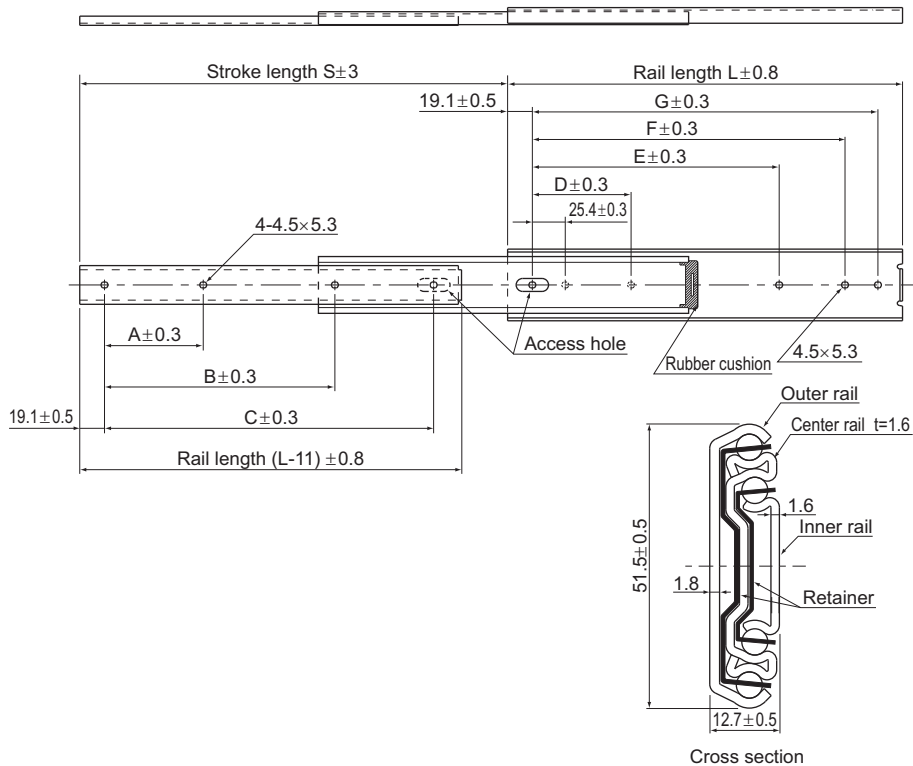

Cross section

Unit: mm

Rail length L (±0.8)	Stroke S (±3)	Mounting hole dimensions							Mounting hole		Permissible load N/pair	Mass kg/pair
		A	B	C	D	E	F	G	Inner rail	Outer rail		
305	330	76.2	177.8	254	76.2	190.5	241.3	266.7	4	6	850	1.46
356	381	101.6	203.2	304.8	88.9	215.9	292.1	317.5	4	6	820	1.72
406	432	127	228.6	355.6	127	241.3	342.9	368.3	4	6	770	1.89
457	483	127	279.4	406.4	127	292.1	393.7	419.1	4	6	730	2.26
508	533	152.4	304.8	457.2	152.4	317.5	444.5	469.9	4	6	710	2.52
559	584	177.8	330.2	508	177.8	342.9	495.3	520.7	4	6	690	2.72
610	635	177.8	381	558.8	177.8	393.7	546.1	571.5	4	6	660	3
660	686	203.2	406.4	609.6	203.2	419.1	596.9	622.3	4	6	630	3.25
711	737	228.6	431.8	660.4	228.6	444.5	647.7	673.1	4	6	610	3.54
762	787	228.6	457.2	711.2	228.6	469.9	698.5	723.9	4	6	580	3.86

Note: The Permissible Load and Mass each indicate when used as a pair of 2 units.

Model number coding

FBL51H +610L

Model number Overall rail length (mm)

Model FBL 51H-P13

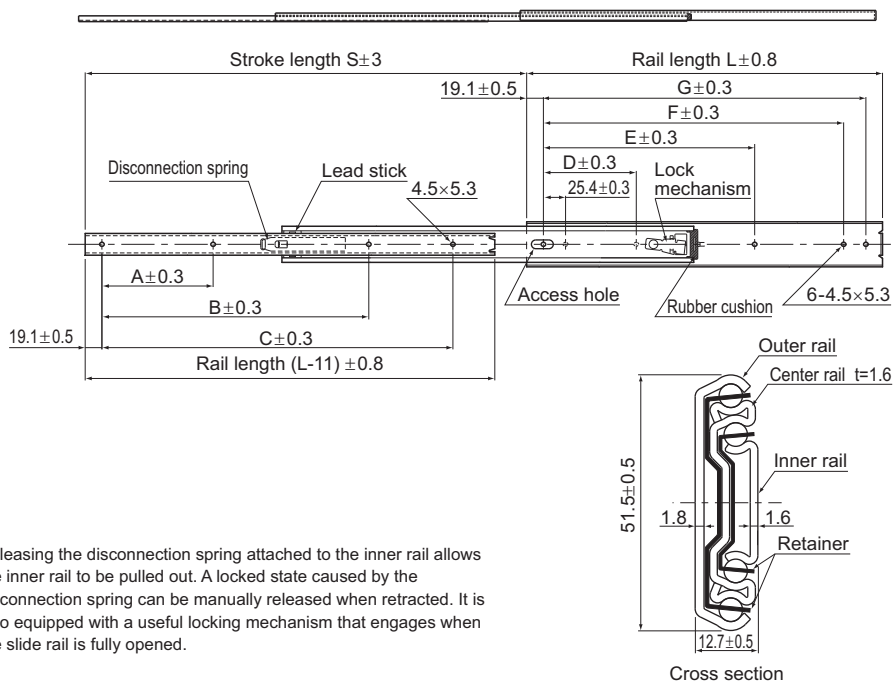

Releasing the disconnection spring attached to the inner rail allows the inner rail to be pulled out. A locked state caused by the disconnection spring can be manually released when retracted. It is also equipped with a useful locking mechanism that engages when the slide rail is fully opened.

Cross section

Unit: mm

Rail length L (±0.8)	Stroke S (±3)	Mounting hole dimensions							Mounting hole		Permissible load N/pair	Mass kg/pair
		A	B	C	D	E	F	G	Inner rail	Outer rail		
305	330	76.2	—	190.5	76.2	190.5	241.3	266.7	3	6	850	1.46
356	381	101.6	—	266.7	88.9	215.9	292.1	317.5	3	6	820	1.72
406	432	127	—	304.8	127	241.3	342.9	368.3	3	6	770	1.89
457	483	127	317.5	368.3	127	292.1	393.7	419.1	4	6	730	2.26
508	533	152.4	355.6	406.4	152.4	317.5	444.5	469.9	4	6	710	2.52
559	584	177.8	381	457.2	177.8	342.9	495.3	520.7	4	6	690	2.72
610	635	177.8	430.8	508	177.8	393.7	546.1	571.5	4	6	660	3
660	686	203.2	457.2	558.8	203.2	419.1	596.9	622.3	4	6	630	3.25
711	737	228.6	508	609.6	228.6	444.5	647.7	673.1	4	6	610	3.54
762	787	228.6	533.4	660.4	228.6	469.9	698.5	723.9	4	6	580	3.86

Note: The Permissible Load and Mass each indicate when used as a pair of 2 units.

Model number coding

FBL51H-P13 +559L

Model number

Overall rail length (mm)

Model FBL 51H-P14

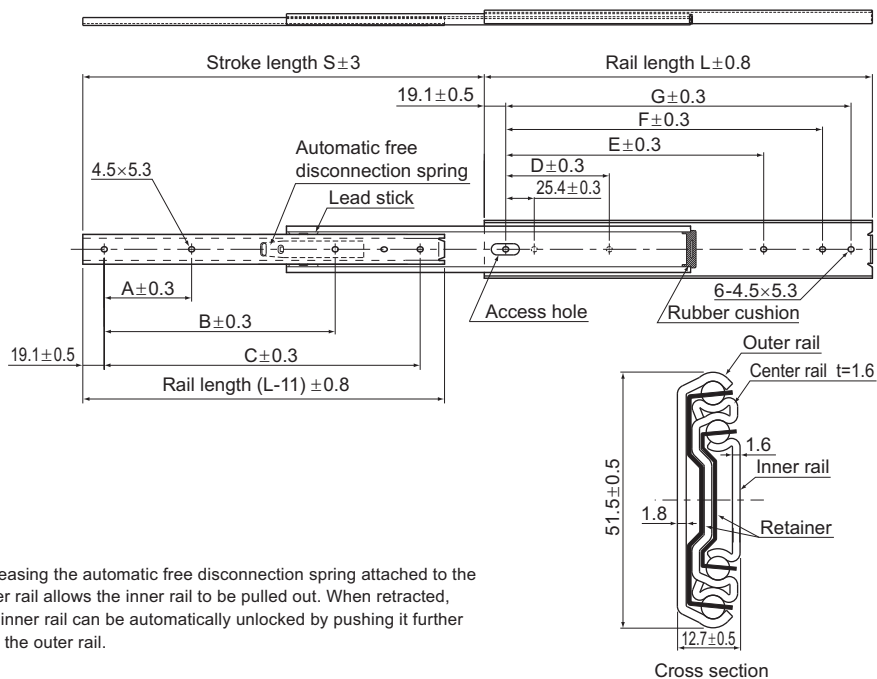

Releasing the automatic free disconnection spring attached to the inner rail allows the inner rail to be pulled out. When retracted, the inner rail can be automatically unlocked by pushing it further into the outer rail.

Unit: mm

Rail length L (±0.8)	Stroke S (±3)	Mounting hole dimensions							Mounting hole		Permissible load N/pair	Mass kg/pair
		A	B	C	D	E	F	G	Inner rail	Outer rail		
305	330	76.2	—	254	76.2	190.5	241.3	266.7	3	6	850	1.46
356	381	127	—	304.8	88.9	215.9	292.1	317.5	3	6	820	1.72
406	432	152.4	317.5	355.6	127	241.3	342.9	368.3	4	6	770	1.89
457	483	177.8	368.3	406.4	127	292.1	393.7	419.1	4	6	730	2.26
508	533	152.4	419.1	457.2	152.4	317.5	444.5	469.9	4	6	710	2.52
559	584	177.8	469.9	508	177.8	342.9	495.3	520.7	4	6	690	2.72
610	635	177.8	520.7	558.8	177.8	393.7	546.1	571.5	4	6	660	3
660	686	203.2	571.5	609.6	203.2	419.1	596.9	622.3	4	6	630	3.25
711	737	228.6	622.3	660.4	228.6	444.5	647.7	673.1	4	6	610	3.54
762	787	228.6	673.1	711.2	228.6	469.9	698.5	723.9	4	6	580	3.86

Note: The Permissible Load and Mass each indicate when used as a pair of 2 units.

Model number coding

FBL51H-P14 +305L

Model number

Overall rail length (mm)

Model FBL 35K

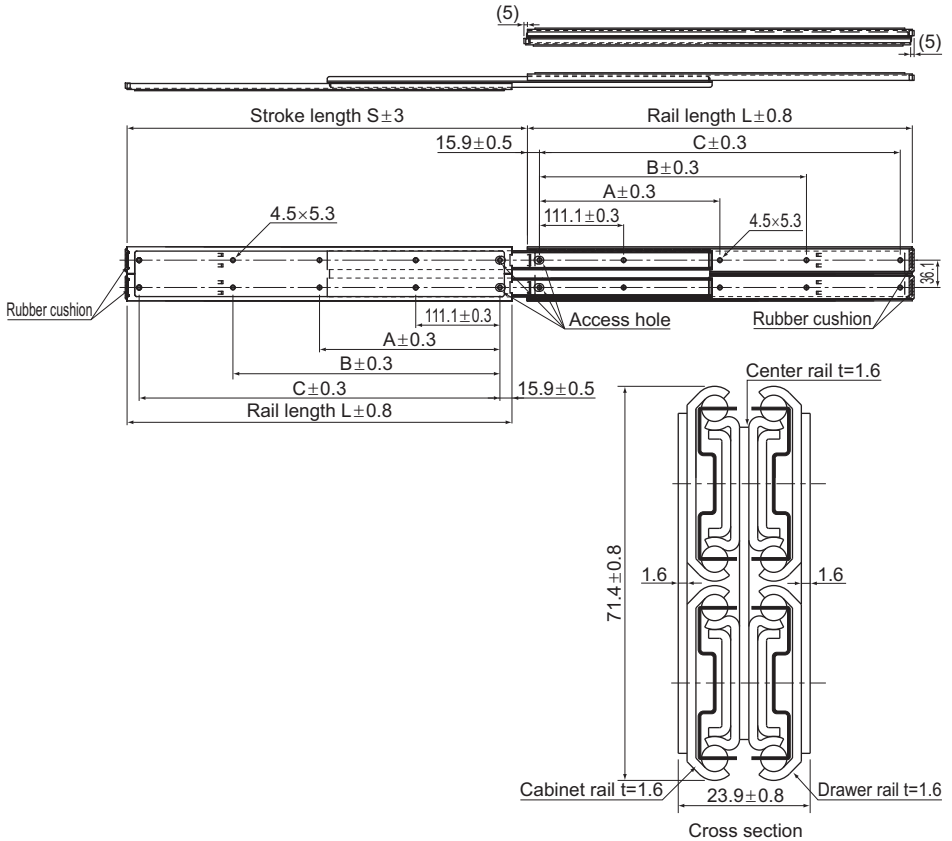

Unit: mm

Rail length L (±0.8)	Stroke S (±3)	Mounting hole dimensions			Mounting hole		Permissible load N/pair	Mass kg/pair
		A	B	C	Drawer rail	Cabinet rail		
305	327	—	149.2	273	4	4	2670	4.04
356	378	—	200	323.8	4	4	2630	4.8
406	429	—	250.8	374.6	4	4	2540	5.6
457	480	212.7	301.6	425.4	5	5	2450	6.04
508	530	238.1	352.4	476.2	5	5	2360	6.92
559	581	263.5	403.2	527	5	5	2250	7.56
610	632	288.9	454	577.8	5	5	2120	8.4
660	683	314.3	504.8	628.6	5	5	1960	9
711	734	339.7	555.6	679.4	5	5	1780	9.68

Notes: The Permissible Load and Mass each indicate when used as a pair of 2 units.

The product has a rubber cushion. If desiring to keep the length within the rail length when storing the product, remove the rubber cushion.

Model number coding

FBL35K +711L

Model number Overall rail length (mm)

Model FBL 56H

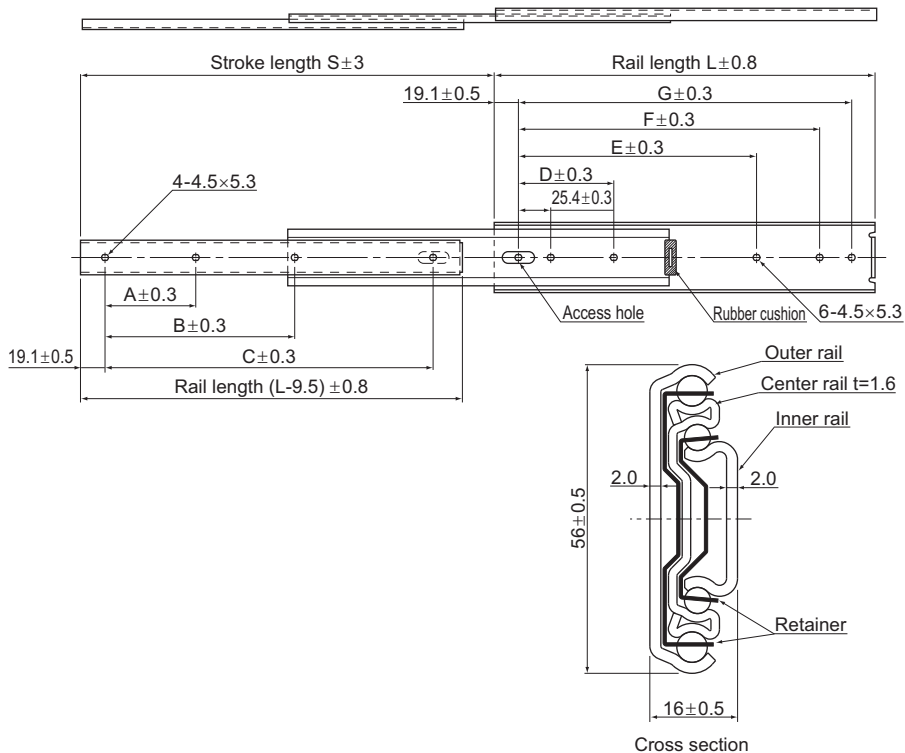

Unit: mm

Rail length L (±0.8)	Stroke S (±0.3)	Mounting hole dimensions							Mounting hole		Permissible load N/pair	Mass kg/pair
		A	B	C	D	E	F	G	Inner rail	Outer rail		
305	330	76.2	177.8	254	76.2	190.5	241.3	266.7	4	6	961	1.76
356	381	101.6	203.2	304.8	88.9	215.9	292.1	317.5	4	6	951	2.04
406	432	127	228.6	355.6	127	241.3	342.9	368.3	4	6	941	2.36
457	483	127	279.4	406.4	127	292.1	393.7	419.1	4	6	922	2.64
508	533	152.4	304.8	457.2	152.4	317.5	444.5	469.9	4	6	902	2.96
559	584	177.8	330.2	508	177.8	342.9	495.3	520.7	4	6	882	3.24
610	635	177.8	381	558.8	177.8	393.7	546.1	571.5	4	6	863	3.6
660	686	203.2	406.4	609.6	203.2	419.1	596.9	622.3	4	6	843	3.84
711	737	228.6	431.8	660.4	228.6	444.5	647.7	673.1	4	6	824	4.06
762	787	228.6	457.2	711.2	228.6	469.9	698.5	723.9	4	6	784	4.44

Note: The Permissible Load and Mass each indicate when used as a pair of 2 units.

Model number coding

FBL56H +406L

Model number Overall rail length (mm)

Model FBL 56H-P13

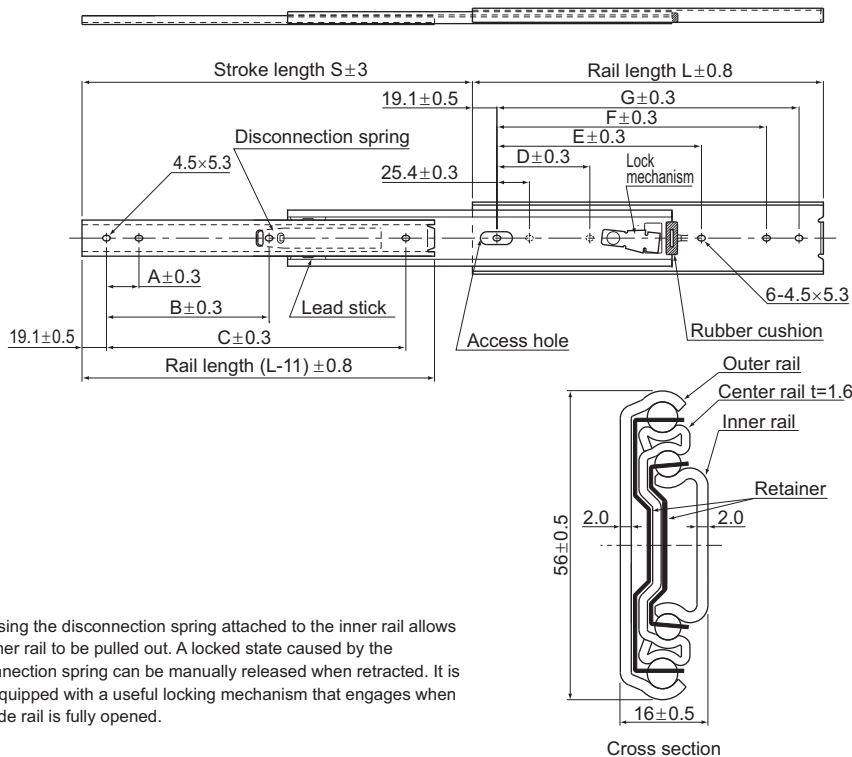

Releasing the disconnection spring attached to the inner rail allows the inner rail to be pulled out. A locked state caused by the disconnection spring can be manually released when retracted. It is also equipped with a useful locking mechanism that engages when the slide rail is fully opened.

Cross section

Unit: mm

Rail length L (±0.8)	Stroke S (±3)	Mounting hole dimensions							Mounting hole		Permissible load N/pair	Mass kg/pair
		A	B	C	D	E	F	G	Inner rail	Outer rail		
305	330	76.2	—	254	76.2	190.5	241.3	266.7	3	6	961	1.76
356	381	127	—	304.8	88.9	215.9	292.1	317.5	3	6	951	2.04
406	432	152.4	317.5	355.6	127	241.3	342.9	368.3	4	6	941	2.36
457	483	177.8	368.3	406.4	127	292.1	393.7	419.1	4	6	922	2.64
508	533	152.4	419.1	457.2	152.4	317.5	444.5	469.9	4	6	902	2.96
559	584	177.8	469.9	508	177.8	342.9	495.3	520.7	4	6	882	3.24
610	635	177.8	520.7	558.8	177.8	393.7	546.1	571.5	4	6	863	3.6
660	686	203.2	571.5	609.6	203.2	419.1	596.9	622.3	4	6	843	3.84
711	737	228.6	622.3	660.4	228.6	444.5	647.7	673.1	4	6	824	4.06
762	787	228.6	673.1	711.2	228.6	469.9	698.5	723.9	4	6	784	4.44

Note: The Permissible Load and Mass each indicate when used as a pair of 2 units.

Model number coding

FBL56H-P13 +762L

Model number

Overall rail length (mm)

Model FBL 56H-P14

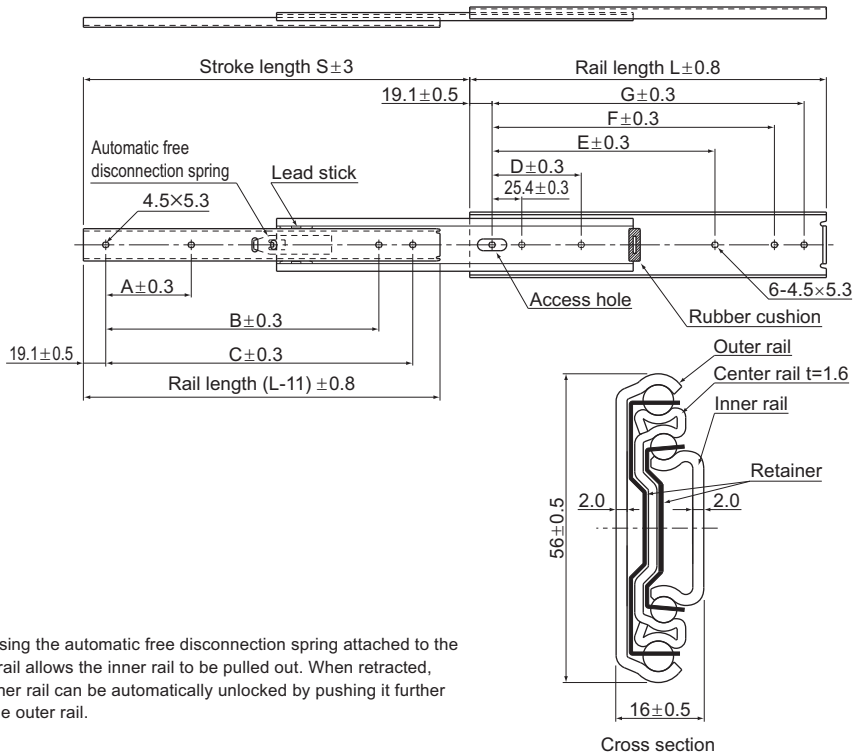

Releasing the automatic free disconnection spring attached to the inner rail allows the inner rail to be pulled out. When retracted, the inner rail can be automatically unlocked by pushing it further into the outer rail.

Cross section

Unit: mm

Rail length L (±0.8)	Stroke S (±3)	Mounting hole dimensions							Mounting hole		Permissible load N/pair	Mass kg/pair
		A	B	C	D	E	F	G	Inner rail	Outer rail		
305	330	76.2	—	254	76.2	190.5	241.3	266.7	3	6	961	1.76
356	381	127	—	304.8	88.9	215.9	292.1	317.5	3	6	951	2.04
406	432	152.4	317.5	355.6	127	241.3	342.9	368.3	4	6	941	2.36
457	483	177.8	368.3	406.4	127	292.1	393.7	419.1	4	6	922	2.64
508	533	152.4	419.1	457.2	152.4	317.5	444.5	469.9	4	6	902	2.96
559	584	177.8	469.9	508	177.8	342.9	495.3	520.7	4	6	882	3.24
610	635	177.8	520.7	558.8	177.8	393.7	546.1	571.5	4	6	863	3.6
660	686	203.2	571.5	609.6	203.2	419.1	596.9	622.3	4	6	843	3.84
711	737	228.6	622.3	660.4	228.6	444.5	647.7	673.1	4	6	824	4.06
762	787	228.6	673.1	711.2	228.6	469.9	698.5	723.9	4	6	784	4.44

Note: The Permissible Load and Mass each indicate when used as a pair of 2 units.

Model number coding

FBL56H-P14 +457L

Model number

Overall rail length (mm)

Model FBL 35F

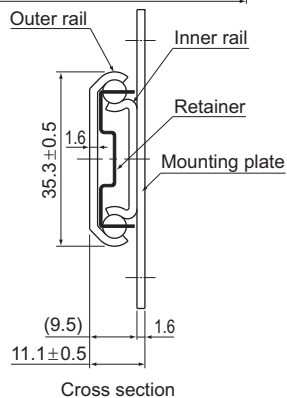
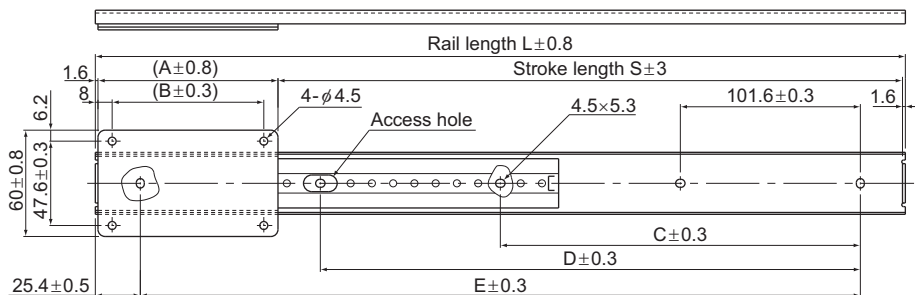

Cross section

Unit: mm

Mass Unit: kg/pair

Rail length L (±0.8) mm	Mounting plate Model No.					
	#3	#4	#5	#6	#7	#8
305	0.6	0.67	0.74	0.81	—	—
356	0.66	0.73	0.8	0.87	0.94	1.01
406	0.73	0.8	0.87	0.94	1.01	1.08
457	0.8	0.87	0.94	1.01	1.08	1.15
508	0.86	0.93	1	1.07	1.14	1.21
559	0.93	1	1.07	1.14	1.21	1.28
610	1	1.07	1.14	1.21	1.28	1.35
660	1.06	1.13	1.2	1.27	1.34	1.41
711	1.13	1.2	1.27	1.34	1.41	1.48
762	1.2	1.27	1.34	1.41	1.48	1.55

Mounting plate	Model No.	#3	#4	#5	#6	#7	#8	Dimension of the outer rail mounting hole (±0.3)		
	Length (A±0.8)	76.2	101.6	127	152.4	177.8	203.2	C	D	E
Rail length L (±0.8)		Stroke length S (±3) ¹						C	D	E
305		225.4	200	174.6	149.2	—	—	—	152.4	254
356		276.2	250.8	225.4	200	174.6	149.2	—	203.2	304.8
406		327	301.6	276.2	250.8	225.4	200	—	254	355.6
457		377.8	352.4	327	301.6	276.2	250.8	203.2	304.8	406.4
508		428.6	403.2	377.8	352.4	327	301.6	228.6	355.6	457.2
559		479.4	454	428.6	403.2	377.8	352.4	254	406.4	508
610		530.2	504.8	479.4	454	428.6	403.2	279.4	457.2	558.8
660		581	555.6	530.2	504.8	479.4	454	304.8	508	609.6
711		631.8	606.4	581	555.6	530.2	504.8	330.2	558.8	660.4
762		682.6	657.2	631.8	606.4	581	555.6	355.6	609.6	711.2
Pitch of the mounting plate mounting hole (B±0.3)		60.2	85.6	111	136.4	161.8	187.2	—	—	—
Permissible load (N/pair)		294	392	490	588	686	784	—	—	—

¹ The stroke length varies with the combination with the mounting plate above.
Note: The Permissible Load and Mass each indicate when used as a pair of 2 units.

Model number coding

FBL35F +356L #5

Model number

Model number of mounting plate

Overall rail length (mm)

Model E36RS

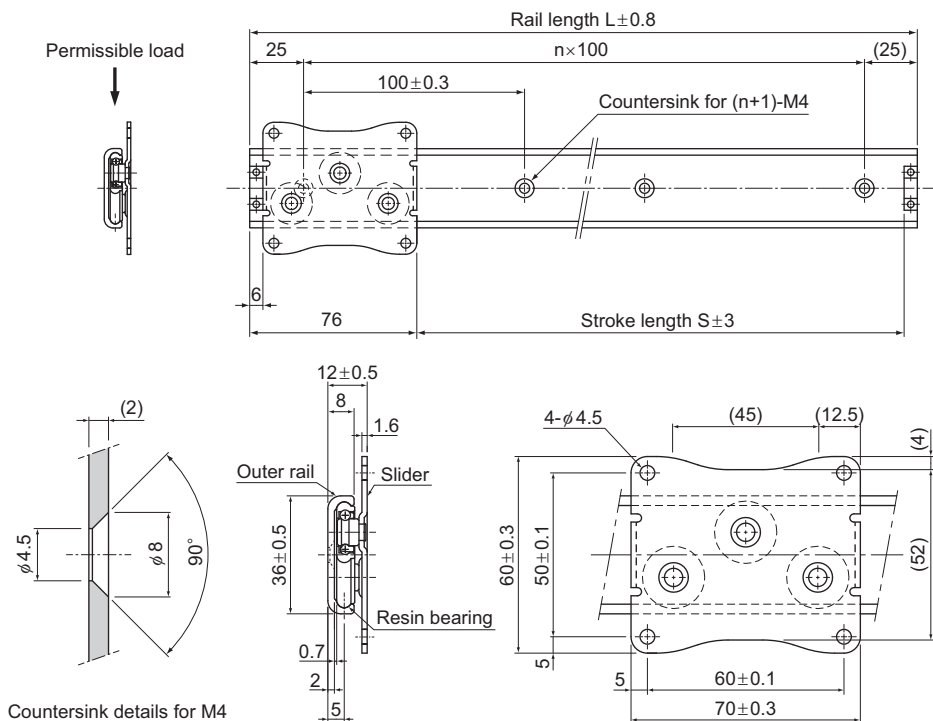

Unit: mm

Rail length L (± 0.8)	Stroke length S (± 3)	n	Mounting hole n+1	Permissible load ¹ N	Mass g
150	68	1	2	40	104
250	168	2	3	40	130
350	268	3	4	40	156
450	368	4	5	40	182
550	468	5	6	40	207
650	568	6	7	40	233
750	668	7	8	40	259

¹ Model E36RS differs from other slide rails by assuming use with a single rail. Therefore, the value is per single rail for permissible load.

Model number coding

E36RS +550L

Model number Overall rail length (mm)

Model E15

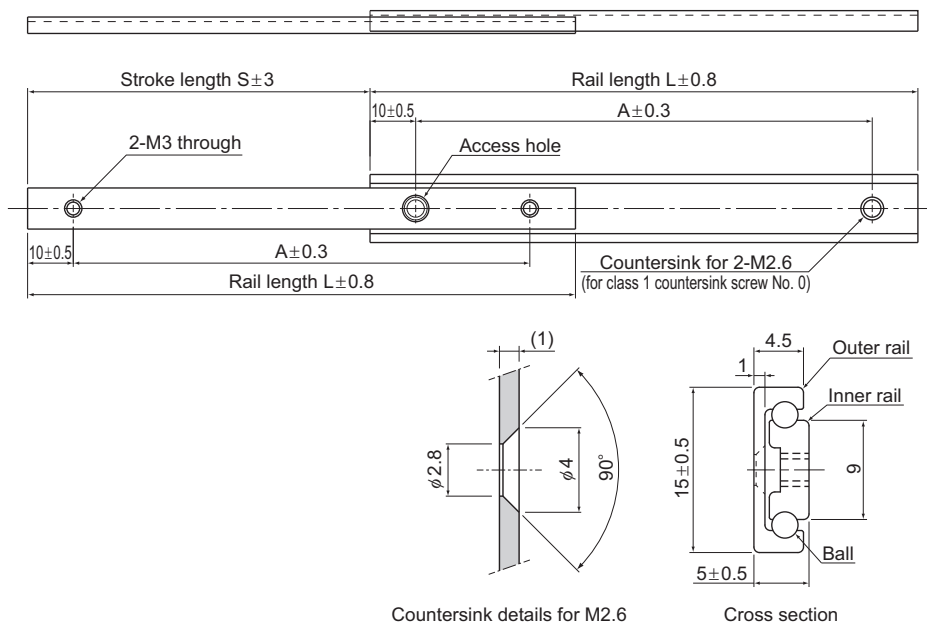

Countersink details for M2.6

Cross section

Unit: mm

Rail length L (± 0.8)	Stroke S (± 3)	Mounting hole dimensions A ± 0.3	Permissible load N/pair	Mass [g/pair]
50	20	30	5	15
80	45	60	8	24
100	60	80	10	30
120	75	100	10	36

Note: The Permissible Load and Mass each indicate when used as a pair of 2 units.

Model number coding

E15 +100L

Model number Overall rail length (mm)

Model E20

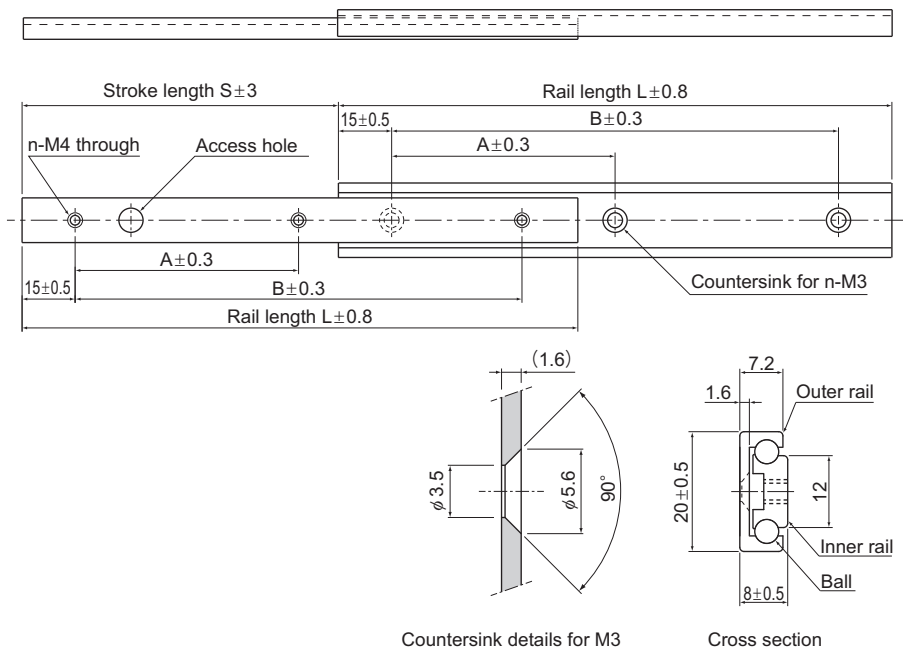

Unit: mm

Rail length $L (\pm 0.8)$	Stroke $S (\pm 3)$	Mounting hole dimensions			Permissible load N/pair	Mass [g/pair]
		$A \pm 0.3$	$B \pm 0.3$	n (pcs)		
80	45	50	—	2	20	50
100	60	70	—	2	30	62
150	85	60	120	3	80	98
200	120	85	170	3	140	131
300	180	135	270	3	145	197

Note: The Permissible Load and Mass each indicate when used as a pair of 2 units.

Model number coding

E20 +150L

Model number Overall rail length (mm)

Model D20

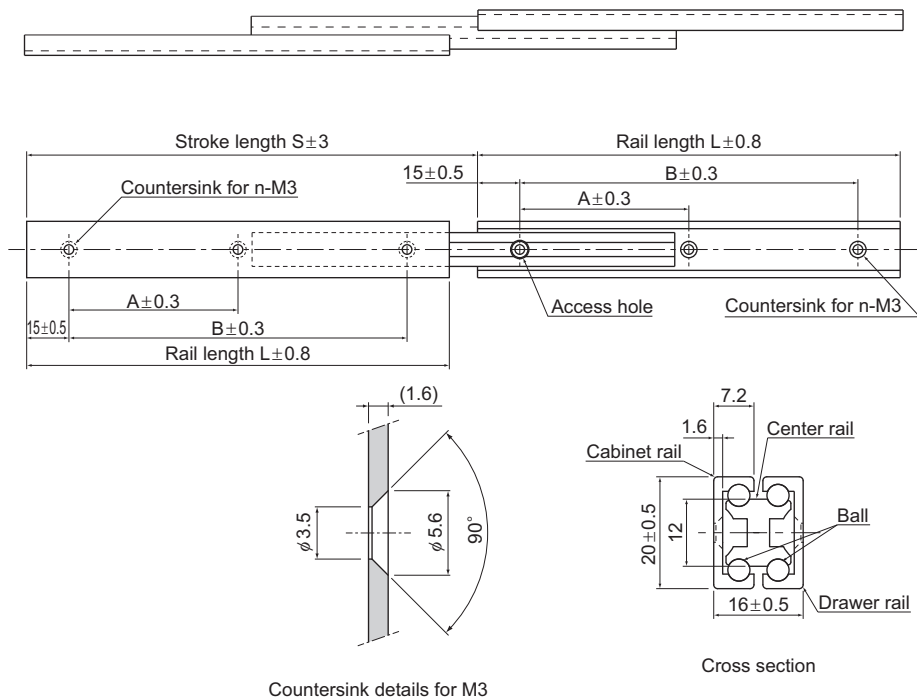

Unit: mm

Rail length $L (\pm 0.8)$	Stroke $S (\pm 3)$	Mounting hole dimensions			Permissible load N/pair	Mass [g/pair]
		A ± 0.3	B ± 0.3	n (pcs)		
80	80	50	—	2	20	94
100	100	70	—	2	30	118
150	160	60	120	3	80	179
200	223	85	170	3	140	241
300	345	135	270	3	145	364

Note: The Permissible Load and Mass each indicate when used as a pair of 2 units.

Model number coding

D20 +300L

Model number Overall rail length (mm)

Point of Design

Slide Rail

[Permissible Load and Mounting Orientation]

For use other than with the mounting orientation shown in Fig.1, contact THK.

The permissible load of the Slide Rail indicates the load in the direction P_a that two rails can receive in the middle of the inner rail length at the maximum stroke.

The mounting orientation shown in Fig.2 is applicable to model FBL35B only.

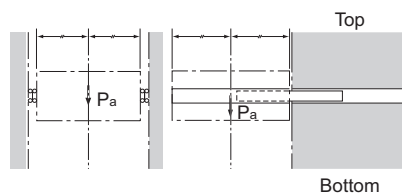

Fig.1

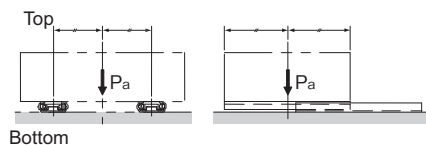

Fig.2

The mounting orientation of Fig.3 is applicable to model FBL35F.

The mounting orientation of Fig.4 is applicable to model E36RS.

Unlike other slide rails, model E36RS is used in a single rail configuration. Therefore, the load must be centered on the ball and the cage center line.

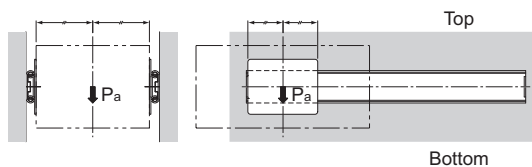

Fig.3

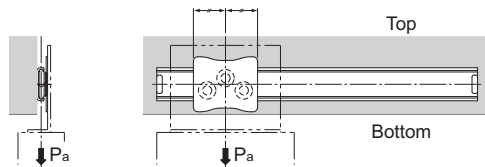

Fig.4

[Surface Treatment]

The surface of the Slide Rail is electro-galvanized (treated with trivalent chromate) as standard.

The aluminum slide rail of models E and D is white alumite-treated as standard. The slider of model E36RS is electro-galvanized (trivalent chromate treatment) and the rail is white alumite-treated as standard. For other surface treatments, contact THK.

Model Number Coding

Model number configurations differ depending on the model features. Refer to the corresponding sample model number configuration.

[Single slide/Double slide]

- Models FBL 27S, FBL 27S-P14, FBL 35S, FBL 35S-P13, FBL 35S-P14, FBL 35M, FBL 35J, FBL 35B, FBL 27D, FBL 35N, FBL 35N-P16, FBL 35G-P13, FBL 35G-P14, FBL 35D, FBL 51H, FBL 51H-P13, FBL 51H-P14, FBL 35K, FBL 56H, FBL 56H-P13 and FBL 56H-P14
-

FBL27S +300L

Model No.
Overall rail length (in mm)

[Linear Type Slides]

- Model FBL35F
-

FBL35F +356L #5

Model No.
Overall rail length (in mm)
Model number of mounting plate

[Linear Slide Wheel-type]

- Model E36RS
-

E36RS +550L

Model number
Overall rail length (mm)

[Aluminum Alloy Slide Rail]

- Models E15, E20 and D20
-

E15 +100L

Model No.
Overall rail length (in mm)

Precautions on Use

Slide Rail

[Handling]

- (1) Tilting a Slide Rail may cause it to fall by its own weight.
- (2) Do not disassemble the parts. This will result in loss of functionality.
- (3) Take care not to drop or strike the Slide Rail. Doing so may cause injury or damage. Giving an impact to it could also cause damage to its function even if the product looks intact.
- (4) When handling the product, wear protective gloves, safety shoes, etc., as necessary to ensure safety.

[Precautions on Use]

- (1) When mounting the Slide Rail, use care to always keep both rails in parallel.
- (2) Prevent foreign material, such as cutting chips or coolant, from entering the product. Failure to do so may cause damage.
- (3) If the product is used in an environment where cutting chips, coolant, corrosive solvents, water, etc., may enter the product, use bellows, covers, etc., to prevent them from entering the product.
- (4) If foreign material such as cutting chips adheres to the product, replenish the lubricant after cleaning the product.
- (5) Avoid using the product at other than normal temperature, or using it in harsh conditions such as intensive reciprocations that generate frictional heat and environments with water or dust.
- (6) The durability of the Slide Rail varies depending on factors such as the drawing dimension, travel distance, mounting conditions and environment in addition to operating frequency. Take these factors into account when making a selection.
- (7) Note that the cage creep may occur if the slide rail is mounted vertically, subject to machine vibrations, etc. To correct the cage creep, fully open and fully close the slide rail. During this process, the motion will be less smooth than usual. If cage creep is inevitable, we recommend using Slide Packs, LM Guides, etc., which are infinite stroke linear motion systems.
- (8) If you replace an old slider or outer rail of your E36RS with a new one, the clearance and sliding resistance may substantially increase.
- (9) Do not use the supplied stopper as a mechanical stopper. This may damage the stopper due to impact.
- (10) Do not use undue force when fitting parts (pin, key, etc.) to the product. This may generate pressure marks on the raceway, leading to loss of functionality.
- (11) Insufficient rigidity or accuracy of mounting members causes the bearing load to concentrate on one point and the bearing performance will drop significantly. Accordingly, give sufficient consideration to the rigidity/accuracy of the housing and base and strength of the fixing bolts.

[Lubrication]

- (1) Lithium soap-based grease No. 2 is applied to the slide rail. Do not mix different lubricants. Even greases containing the same type of thickening agent may, if mixed, interact adversely due to disparate additives or other ingredients.
- (2) The consistency of grease changes according to the temperature. Take note that the slide resistance of the Slide Rail also changes as the consistency of grease changes.
- (3) After lubrication, the slide resistance of the Slide Rail may increase due to the agitation resistance of grease. Be sure to let the grease spread fully before use.
- (4) Excess grease may scatter immediately after lubrication, so wipe off scattered grease as necessary.
- (5) The properties of grease deteriorate and its lubrication performance drops over time, so grease must be checked and added properly according to the use frequency of the machine.
- (6) The greasing interval varies depending on the use condition and service environment. Set the final lubrication interval/amount based on the actual machine.

[Storage]

When storing the Slide Rail, enclose it in a package designated by THK and store it in a room in a horizontal orientation while avoiding high temperature, low temperature and high humidity.

After the product has been in storage for an extended period of time, lubricant inside may have deteriorated, so add new lubricant before use.

[Disposal]

Dispose of the product properly as industrial waste.



Slide Rail

THK General Catalog

B Support Book

Features and Types	A13-2
Features of the Slide Rail	A13-2
• Structure and Features	A13-2
Slide Rail Types	A13-3
• Types and Features	A13-3
Classification Table for Slide Rails.....	A13-12
Mounting Procedure	A13-14
Mounting the Slide Rail.....	A13-14
Model No.	A13-17
• Model Number Coding	A13-17
Precautions on Use	A13-18

A Product Descriptions (Separate)

Features and Types	A13-2
Features of the Slide Rail	A13-2
• Structure and Features	A13-2
Slide Rail Types	A13-3
• Types and Features	A13-3
Classification Table for Slide Rails.....	A13-12

Dimensional Drawing, Dimensional Table

Model FBL 27S	A13-14
Model FBL 27S-P14	A13-15
Model FBL 35S	A13-16
Model FBL 35S-P13	A13-17
Model FBL 35S-P14	A13-18
Model FBL 35M	A13-19
Model FBL 35J	A13-20
Model FBL 35B	A13-21
Model FBL 27D	A13-22
Model FBL 35N	A13-24
Model FBL 35N-P16	A13-25
Model FBL 35G-P13	A13-26
Model FBL 35G-P14	A13-27
Model FBL 35D	A13-28
Model FBL 51H	A13-29
Model FBL 51H-P13	A13-30
Model FBL 51H-P14	A13-31
Model FBL 35K	A13-32
Model FBL 56H	A13-33
Model FBL 56H-P13	A13-34
Model FBL 56H-P14	A13-35
Model FBL 35F	A13-36
Model E36RS	A13-37
Model E15	A13-38
Model E20	A13-39
Model D20	A13-40

Point of Design	A13-41
------------------------------	--------

Model No.	A13-43
• Model Number Coding	A13-43

Precautions on Use	A13-44
---------------------------------	--------

Features of the Slide Rail

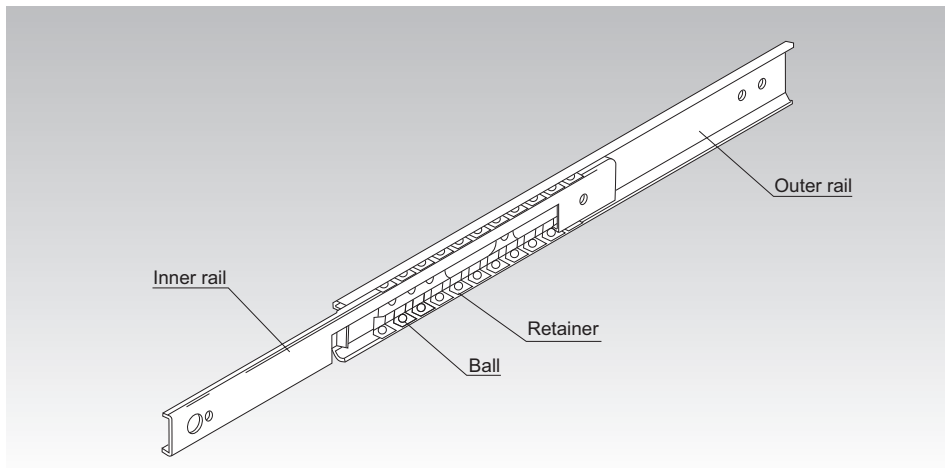

Fig.1 Structure of Slide Rail Model FBL

Structure and Features

Slide rails are low-price finite linear guides made out of precision roll-formed steel plates. They are suitable as linear motion guides for various applications because they are thin, compact, and easy to mount. Slide rails can be used in a wide range of applications such as photocopiers, measuring instruments, telecommunications equipment, medical equipment, automatic vending machines, and various types of office equipment.

The Model FBL slide rail has two rows of ball bearings placed between an inner rail and an outer rail that have been roll-formed out of steel plates. The ball bearings are evenly spaced by a precisely press-molded retainer, eliminating friction between the bearings and achieving a smooth sliding mechanism.

[Allows Easy Installation]

Simple to mount on the mounting surface. Since retainers hold the bearings, they do not fall out even if the inner rail is removed.

[Thin and Compact]

The thin cross section of the Model FBL slide rail means it can be installed in small spaces, and it is suitable for places where space saving is required.

[High Corrosion Resistance]

The Model FBL slide rail is treated with zinc plating, and models E and D are treated with a white anodized aluminum coating, making them highly corrosion-resistant.

Slide Rail Types

Types and Features

[Single Slides for Light Load]

Model FBL 27S

The most compact slide rail.

Specification Table⇒ **A** 13-14

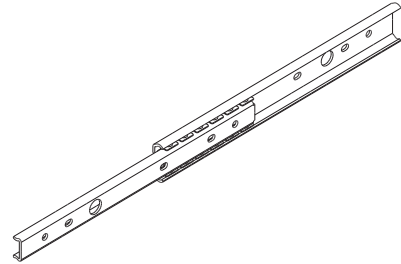

Model FBL 27S

Model FBL 27S-P14

The Model FBL 27S features a removable inner rail. When retracted, the inner rail can be automatically unlocked by pushing it further into the outer rail.

Specification Table⇒ **A** 13-15

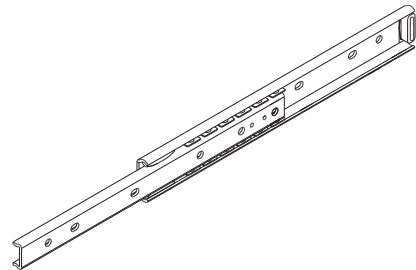

Model FBL 27S-P14

Model FBL 35S

A single slide type of slide rail with the most fundamental shape.

Specification Table⇒ **A** 13-16

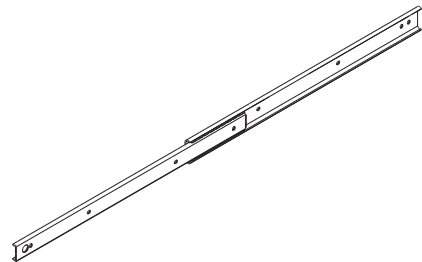

Model FBL 35S

Model FBL 35S-P13

The Model FBL 35S features a removable inner rail. When retracted, it can be unlocked manually.

Specification Table⇒ [A13-17](#)

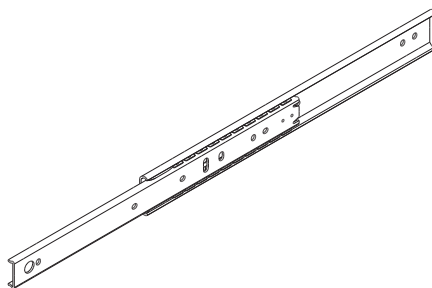

Model FBL 35S-P13

Model FBL 35S-P14

The Model FBL 35S features a removable inner rail. When retracted, the inner rail can be automatically unlocked by pushing it further into the outer rail.

Specification Table⇒ [A13-18](#)

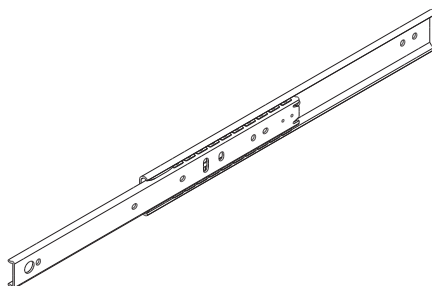

Model FBL 35S-P14

Model FBL 35M

The Model FBL 35S features a removable inner rail. The slide rail is designed to stop by frictional resistance when it is fully opened. Remove the inner rail by applying more force. (Includes a brake stop)

Specification Table⇒ [A13-19](#)

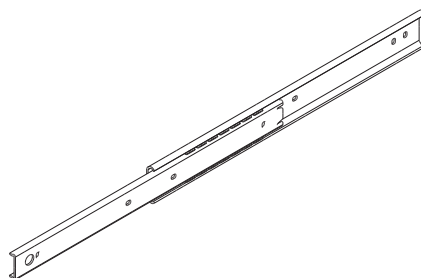

Model FBL 35M

Features and Types

Slide Rail Types

Model FBL 35J

The Model FBL 35M with additional lead ball that serves as a guide when the inner rail is inserted.

Specification Table⇒ **A** 13-20

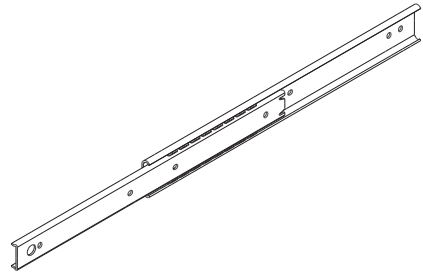

Model FBL 35J

Model FBL 35B

The Model FBL 35M with additional mounting bracket.

Specification Table⇒ **A** 13-21

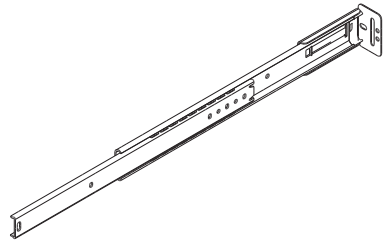

Model FBL 35B

[Double Slides for Light Load]

Model FBL 27D

A double slide with an additional Model FBL 27S attached on the rear side of the inner rail. Widely used in many types of OA equipment.

Specification Table⇒ **A13-22**

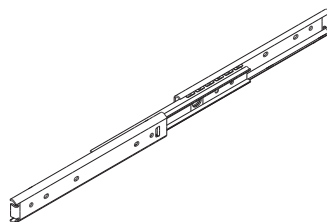

Model FBL 27D

Model FBL 35N

This is a three-rail double slide that allows a long stroke in a small space.

This product uses a plate thickness of 1.2 mm and a light-load double slide rail to achieve weight reduction.

Specification Table⇒ **A13-24**



Model FBL 35N

Model FBL 35N-P16

This is a three-rail double slide that allows a long stroke in a small space. It uses a plate thickness of 1.2 mm and a light-load double slide rail to achieve weight reduction. The inner rail can be pulled out, and it can be reinserted smoothly without the need for a release operation.

Specification Table⇒ **A13-25**

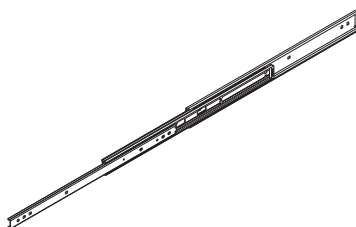

Model FBL 35N-P16

Features and Types

Slide Rail Types

[Double Slides for Medium Load]

Model FBL 35G-P13

A double slide with an additional Model FBL 35S attached on the front side. The drawer rail can be pulled out, and it can be manually unlocked when retracted. It is also equipped with a useful locking mechanism that engages when the slide rail is fully opened.

Specification Table⇒ **A** 13-26

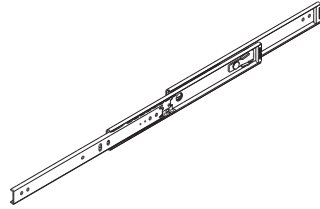

Model FBL 35G-P13

Model FBL 35G-P14

A double slide with an additional Model FBL 35S attached on the front side. The drawer rail can be pulled out, and it can be automatically unlocked by pushing it further into the outer rail. It is also equipped with a useful locking mechanism that engages when the slide rail is fully opened.

Specification Table⇒ **A** 13-27

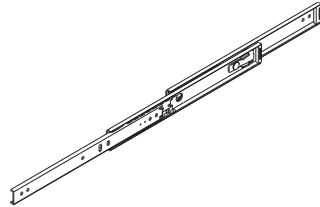

Model FBL 35G-P14

Model FBL 35D

A double slide with an additional Model FBL 35S attached on the rear side of the inner rail. Widely used in a number of different industries.

Specification Table⇒ **A** 13-28

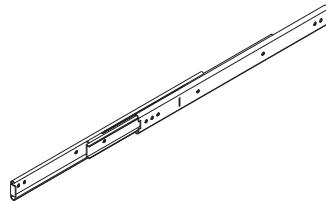

Model FBL 35D

Model FBL 51H

A three-rail double slide that allows a long stroke. A thin model that can be used in small spaces, even with large working loads.

Specification Table⇒ [A13-29](#)

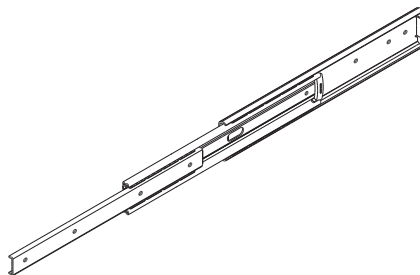

Model FBL 51H

Model FBL 51H-P13

A three-rail double slide that allows a long stroke. A thin model that can be used in small spaces, even with large working loads. The inner rail can be pulled out, and locked states caused by the disconnection spring can be manually released when retracted. It is also equipped with a useful locking mechanism that engages when the slide rail is fully opened.

Specification Table⇒ [A13-30](#)

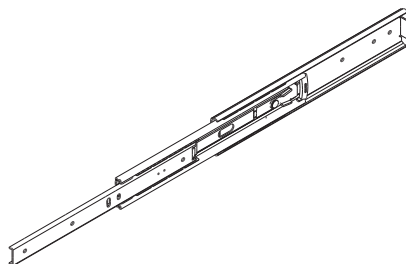

Model FBL 51H-P13

Model FBL 51H-P14

A three-rail double slide that allows a long stroke. A thin model that can be used in small spaces, even with large working loads. The inner rail can be pulled out, and it can be automatically unlocked by pushing it further into the outer rail.

Specification Table⇒ [A13-31](#)

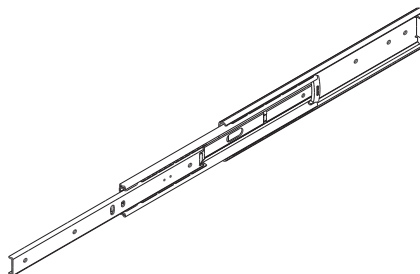

Model FBL 51H-P14

[Double Slides for Heavy Load]**Model FBL 35K**

A double slide combining four Model FBL 35S units. It features the largest allowable load among all models, making it suitable for opening/closing heavy objects.

Specification Table⇒ **A 13-32**

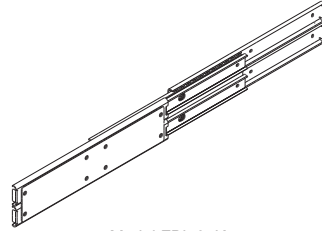

Model FBL 35K

Model FBL 56H

Three-rail double slide with a large allowable load. Widely used in many types of office furniture.

Specification Table⇒ **A 13-33**

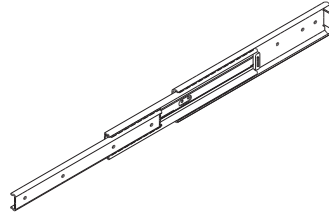

Model FBL 56H

Model FBL 56H-P13

Three-rail double slide with a large allowable load. The inner rail can be pulled out, and it can be manually unlocked when retracted. It is also equipped with a useful locking mechanism that engages when the slide rail is fully opened.

Specification Table⇒ **A 13-34**

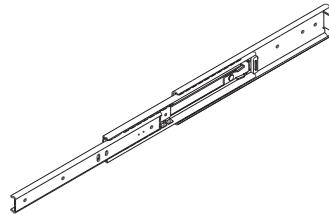

Model FBL 56H-P13

Model FBL 56H-P14

Three-rail double slide with a large allowable load. The inner rail can be pulled out, and it can be automatically unlocked by pushing it further into the outer rail.

Specification Table⇒ **A 13-35**

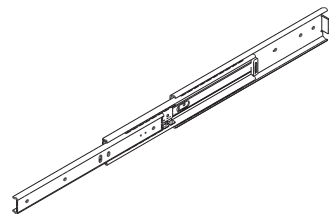

Model FBL 56H-P14

[Linear Type Slides]

Light Load Type Model FBL 35F

Linear-type slide suitable for limited straight motion, featuring a flange for easy mounting.

Specification Table⇒ **A13-36**

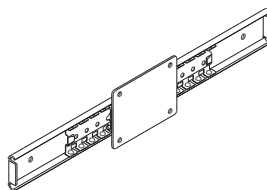

Light Load Type Model FBL 35F

[Wheel-type Linear Slide]

Model E36RS

A linear slide that features wear-resistant resin bearings.

Specification Table⇒ **A13-37**

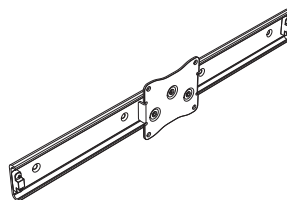

Model E36RS

[Aluminum Alloy Slide Rail]**Light Load Type Model E15**

A compact and lightweight single slide from the aluminum alloy series. Suitable for locations within magnetic fields, locations requiring rust-resistant materials, and locations where appearance is a factor.

Specification Table⇒ **A** 13-38

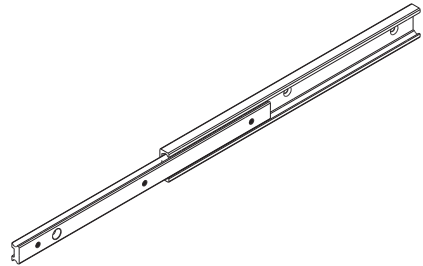

Light Load Type Model E15

Light Load Type Model E20

A basic single slide from the aluminum alloy series. Suitable for locations within magnetic fields, locations requiring rust-resistant materials, and locations where appearance is a factor.

Specification Table⇒ **A** 13-39

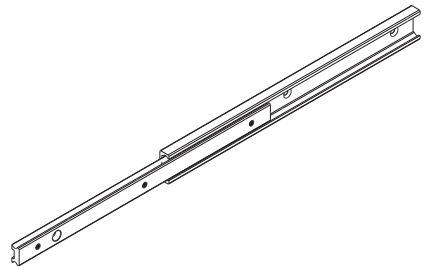

Light Load Type Model E20

Light Load Type Model D20

The most compact and lightweight double slide in the aluminum alloy series. Suitable for locations within magnetic fields, locations requiring rust-resistant materials, and locations where appearance is a factor.

Specification Table⇒ **A** 13-40

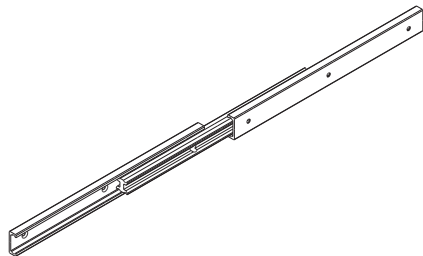

Light Load Type Model D20

Classification Table for Slide Rails

Slide Rail

Single Slide

For Light Load

Model FBL27S

Model FBL27S-P14

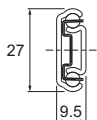

Model FBL35J

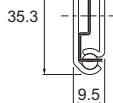

Model FBL35S

Model FBL35S-P13

Model FBL35S-P14

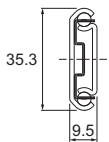

Model FBL35B

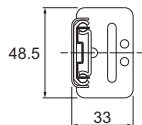

Model E15
(Made of Aluminum)

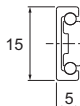

Model FBL35M

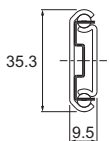

Model E20
(Made of Aluminum)

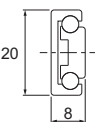

Double Slide

For Light Load

Model FBL27D

Model D20
(Made of aluminum)

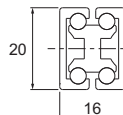
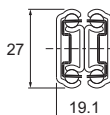

Model FBL35N

Model FBL35N-P16

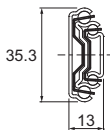

For Medium Load

Model FBL35G-P13

Model FBL51H

Model FBL35G-P14

Model FBL51H-P13

Model FBL51H-P14

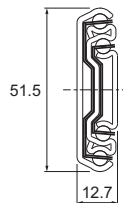
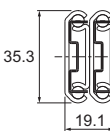

Model FBL35D

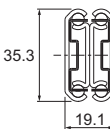

Features and Types

Classification Table for Slide Rails

Linear Type Slide

For Heavy Load

Model FBL35K

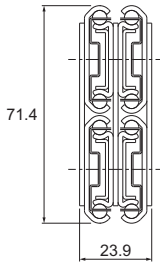

Model FBL56H

Model FBL56H-P13

Model FBL56H-P14

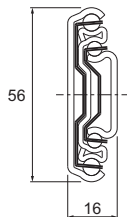

For Light Load

Model FBL35F



Wheel Type

Model E36RS (Aluminum Outer Rail)

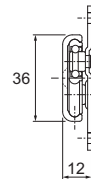

Slide Rail

Mounting the Slide Rail

[Mounting Screws of the Slide Rail]

The slide rail is designed to be mounted using M4 screws. Since the mounting space is small as shown in Fig.1, we recommend using button head or binding head bolts.

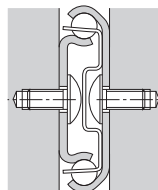

Fig.1

Note that the mounting screw for the slide rail of the models indicated in the following table is different.

Model number	button-head bolt	binding-head bolt	countersink screw
Models FBL27S/27S-P14/27D	M3	M3 , M4	—
Model E15	—	—	M2.6
Models E20/D20	—	—	M3
Model E36RS	—	—	M4

Note: For button head bolts, binding head bolts, and countersink screws, see the appendix of JIS B 1111.

[Attaching the Slide Rail]

At full extension of the slide, mount the outer rail at the overlap of rails. Followed by full retraction of the slide and mount the opposite end using the access hole.

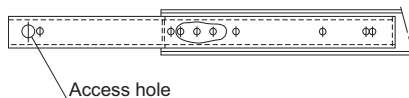

Fig.2

Note: For the following model numbers, mount outer rail after removing inner rail, as shown in Fig.3.

Models: FBL27S-P14, FBL35S-P13, FBL35S-P14, FBL35M, FBL35J, FBL35B, FBL35N-P16, FBL35G-P13, FBL35G-P14, FBL51H-P13, FBL51H-P14, FBL56H-P13, FBL56H-P14

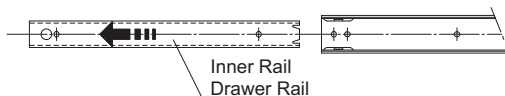

Fig.3

Mounting Procedure

Mounting the Slide Rail

In addition, when mounting the outer rail or cabinet rail of models FBL35G-P13, FBL35G-P14, FBL51H-P13 and FBL56H-P13, which have locking mechanisms, release the lock by pressing the lock plate in the direction indicated in Fig.4 and adjust the position of the access hole.

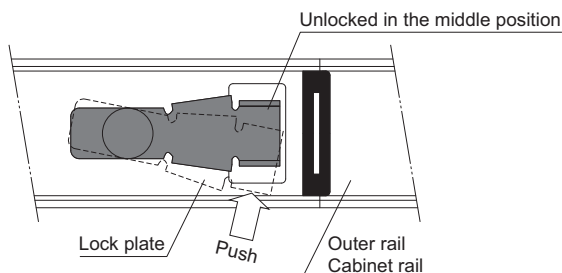

Fig.4

Note: For the following models, mount the inner rail by sliding it in the contracting direction as show in Fig.5. When doing so, do not remove the inner rail from the outer rail. If the inner rail is pulled out, it may be difficult to reinsert.

Models: FBL27S, FBL35S

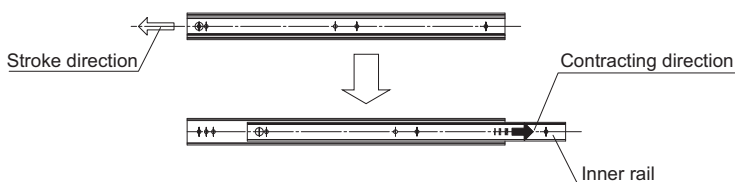

Fig.5

[Permissible Load and Mounting Orientation]

For use other than with the mounting orientation shown in Fig.6, contact THK.

The permissible load of the Slide Rail indicates the load in the direction P_a that two rails can receive in the middle of the inner rail length at the maximum stroke.

The mounting orientation shown in Fig.7 is applicable to "model FBL35B" only.

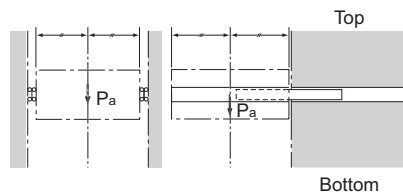

Fig.6

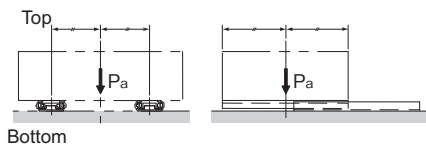

Fig.7 Applicable to "model FBL35B" only

The mounting orientation of Fig.8 is applicable to model FBL35F.

The mounting orientation of Fig.9 is applicable to model E36RS.

Unlike other slide rails, model E36RS is used in a single rail configuration. Therefore, the load must be centered on the ball and the cage center line.

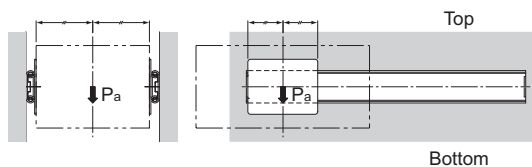

Fig.8

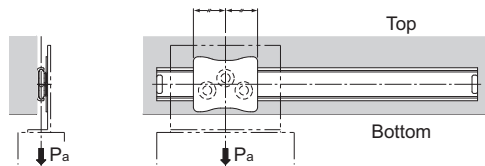

Fig.9

[Surface Treatment]

The surface of the Slide Rail is electro-galvanized (treated with trivalent chromate) as standard.

The aluminum slide rail of models E and D is white alumite-treated as standard. The slider of model E36RS is electro-galvanized (trivalent chromate treatment) and the rail is white alumite-treated as standard. For other surface treatments, contact THK.

Model Number Coding

Model number configurations differ depending on the model features. Refer to the corresponding sample model number configuration.

[Single slide/Double slide]

- Models FBL 27S, FBL 27S-P14, FBL 35S, FBL 35S-P13, FBL 35S-P14, FBL 35M, FBL 35J, FBL 35B, FBL 27D, FBL 35N, FBL 35N-P16, FBL 35G-P13, FBL 35G-P14, FBL 35D, FBL 51H, FBL 51H-P13, FBL 51H-P14, FBL 35K, FBL 56H, FBL 56H-P13 and FBL 56H-P14

FBL27S +300L

Model No. Overall rail length (in mm)

[Linear Type Slides]

- Model FBL35F

FBL35F +356L #5

Model No. Overall rail length (in mm) Model number of mounting plate

[Linear Slide Wheel-type]

- Model E36RS

E36RS +550L

Model number Overall rail length (mm)

[Aluminum Alloy Slide Rail]

- Models E15, E20 and D20

E15 +100L

Model No. Overall rail length (in mm)

Precautions on Use

Slide Rail

[Handling]

- (1) Tilting a Slide Rail may cause it to fall by its own weight.
- (2) Do not disassemble the parts. This will result in loss of functionality.
- (3) Take care not to drop or strike the Slide Rail. Doing so may cause injury or damage. Giving an impact to it could also cause damage to its function even if the product looks intact.
- (4) When handling the product, wear protective gloves, safety shoes, etc., as necessary to ensure safety.

[Precautions on Use]

- (1) When mounting the Slide Rail, use care to always keep both rails in parallel.
- (2) Prevent foreign material, such as cutting chips or coolant, from entering the product. Failure to do so may cause damage.
- (3) If the product is used in an environment where cutting chips, coolant, corrosive solvents, water, etc., may enter the product, use bellows, covers, etc., to prevent them from entering the product.
- (4) If foreign material such as cutting chips adheres to the product, replenish the lubricant after cleaning the product.
- (5) Avoid using the product at other than normal temperature, or using it in harsh conditions such as intensive reciprocations that generate frictional heat and environments with water or dust.
- (6) The durability of the Slide Rail varies depending on factors such as the drawing dimension, travel distance, mounting conditions and environment in addition to operating frequency. Take these factors into account when making a selection.
- (7) Note that the cage creep may occur if the slide rail is mounted vertically, subject to machine vibrations, etc. To correct the cage creep, fully open and fully close the slide rail. During this process, the motion will be less smooth than usual. If cage creep is inevitable, we recommend using Slide Packs, LM Guides, etc., which are infinite stroke linear motion systems.
- (8) If you replace an old slider or outer rail of your E36RS with a new one, the clearance and sliding resistance may substantially increase.
- (9) Do not use the supplied stopper as a mechanical stopper. This may damage the stopper due to impact.
- (10) Do not use undue force when fitting parts (pin, key, etc.) to the product. This may generate pressure marks on the raceway, leading to loss of functionality.
- (11) Insufficient rigidity or accuracy of mounting members causes the bearing load to concentrate on one point and the bearing performance will drop significantly. Accordingly, give sufficient consideration to the rigidity/accuracy of the housing and base and strength of the fixing bolts.

[Lubrication]

- (1) Lithium soap-based grease No. 2 is applied to the slide rail. Do not mix different lubricants. Even greases containing the same type of thickening agent may, if mixed, interact adversely due to disparate additives or other ingredients.
- (2) The consistency of grease changes according to the temperature. Take note that the slide resistance of the Slide Rail also changes as the consistency of grease changes.
- (3) After lubrication, the slide resistance of the Slide Rail may increase due to the agitation resistance of grease. Be sure to let the grease spread fully before use.
- (4) Excess grease may scatter immediately after lubrication, so wipe off scattered grease as necessary.
- (5) The properties of grease deteriorate and its lubrication performance drops over time, so grease must be checked and added properly according to the use frequency of the machine.
- (6) The greasing interval varies depending on the use condition and service environment. Set the final lubrication interval/amount based on the actual machine.

[Storage]

When storing the Slide Rail, enclose it in a package designated by THK and store it in a room in a horizontal orientation while avoiding high temperature, low temperature and high humidity.

After the product has been in storage for an extended period of time, lubricant inside may have deteriorated, so add new lubricant before use.

[Disposal]

Dispose of the product properly as industrial waste.

