



# Accessories for Lubrication

THK General Catalog

## A Product Descriptions

<b>Lubrication</b> .....	A24-2
Types of Lubricants .....	A24-2
• Grease Lubrication .....	A24-3
• Oil Lubrication .....	A24-3
Product Selection According to Usage Environment ..	A24-4
Lubrication Methods .....	A24-5
• Manual Lubrication .....	A24-5
• Forced Lubrication Method .....	A24-5
Lubrication Accessory Series for LM Systems ..	A24-6
• THK Original Grease .....	A24-6
AFA Grease .....	A24-7
AFB-LF Grease .....	A24-9
AFC Grease .....	A24-11
AFE-CA Grease .....	A24-13
AFF Grease .....	A24-15
AFG Grease .....	A24-18
AFJ Grease .....	A24-21
L100 Grease .....	A24-25
L500 Grease .....	A24-27
L700 Grease .....	A24-29
Grease Gun Unit MG70 .....	A24-33
Special Plumbing Fixtures .....	A24-34
Grease Nipple .....	A24-35
Grease Volume by Product .....	A24-36
Glossary .....	A24-37

## B Support Book (Separate)

<b>Lubrication</b> .....	B24-2
Types of Lubricants .....	B24-2
• Grease Lubrication .....	B24-3
• Oil Lubrication .....	B24-3
Product Selection According to Usage Environment ..	B24-4
Lubrication Methods .....	B24-5
• Manual Lubrication .....	B24-5
• Forced Lubrication Method .....	B24-5
Lubrication Accessory Series for LM Systems ..	B24-6
• THK Original Grease .....	B24-6
AFA Grease .....	B24-7
AFB-LF Grease .....	B24-9
AFC Grease .....	B24-11
AFE-CA Grease .....	B24-13
AFF Grease .....	B24-15
AFG Grease .....	B24-18
AFJ Grease .....	B24-21
L100 Grease .....	B24-25
L500 Grease .....	B24-27
L700 Grease .....	B24-29
Grease Gun Unit MG70 .....	B24-33
Special Plumbing Fixtures .....	B24-33
Grease Nipple .....	B24-33
Grease Volume by Product .....	B24-34
Glossary .....	B24-35

To optimize an LM system's functionality, it is necessary to provide lubrication according to the usage conditions. Use without lubrication may increase wear on the rolling elements and shorten the service life.

Lubrication has the following effects:

- (1) Minimizes friction between moving elements to prevent seizure and reduce wear
- (2) Forms an oil film on the raceway to decrease stress acting on the surface and extend rolling fatigue life
- (3) Covers metal surfaces with an oil film to prevent the formation of rust

Even when the LM system has seals, the internal lubricant gradually seeps out during operation. Therefore, the system needs to be lubricated at an appropriate interval according to the usage conditions.

## Types of Lubricants

LM systems mainly use grease or sliding surface oil for their lubricants.

The requirements that lubricants need to satisfy generally consist of the following:

- (1) Extreme pressure resistance
- (2) Reduce friction
- (3) High wear resistance
- (4) High thermal stability
- (5) Excellent rust-proofing performance
- (6) Excellent fluidity
- (7) Consistency of grease must not vary significantly even with repeated stirring

## Grease Lubrication

Greasing intervals vary depending on the usage environment and conditions. For normal use, we recommend greasing the system approximately every 100 km of travel distance (3 to 6 months). When replenishing grease through the LM system's grease nipple and lubrication hole, use grease of the same type. Mixing different types of grease may hinder the system's performance.

Lubricant	Type	Brand name
Grease	Lithium-based grease Urea-based grease Calcium-based grease	AFA Grease see <a href="#">A24-7</a> AFB-LF Grease see <a href="#">A24-9</a> AFC Grease see <a href="#">A24-11</a> AFE-CA Grease see <a href="#">A24-13</a> AFF Grease see <a href="#">A24-15</a> AFG Grease see <a href="#">A24-18</a> AFJ Grease see <a href="#">A24-21</a> L100 Grease see <a href="#">A24-25</a> L500 Grease see <a href="#">A24-27</a> L700 Grease see <a href="#">A24-29</a>  Shell Alvania Grease S (Showa Shell Sekiyu) Daphne Eponex Grease MP (Idemitsu) Equivalent product

Note: The recommended grease will vary according to the usage conditions and environment.

## Oil Lubrication

Lubricant	Type	Brand name
Oil	Sliding surface oil or turbine oil ISOVG32 to 68	Daphne Super Multi Oil (Idemitsu) Mobil Vactra Oil Numbered Series (Exxon Mobil) Mobil Vactra Oil No. 2 SLC (Exxon Mobil) Mobil DTE Oil Series (Exxon Mobil) Shell Tonna S3 M (Showa Shell Sekiyu) Equivalent product

- The amount of oil to be supplied varies with stroke length. For a long stroke, increase the lubrication frequency or the amount of oil applied so that an oil film is able to form along the raceway to the end of the stroke.
- In environments where liquid coolant may spatter, the lubricant may become mixed with the coolant. This could result in the lubricant being emulsified or washed away, causing significantly decreased lubrication performance. In such settings, apply a lubricant with high viscosity (kinematic viscosity: approx. 68 mm<sup>2</sup>/s) and high emulsification resistance, and adjust the lubrication frequency or the amount of feed lubricant.  
For machine tools and similar devices that are subject to heavy loads, require high rigidity, and operate at high speed, oil lubrication is recommended.
- Use only after making sure that the lubrication oil discharges normally from the ends of the lubrication piping, i.e., the oiling ports that connect to your LM system.

## Product Selection According to Usage Environment

When using the product in locations exposed to constant vibrations or under special circumstances such as in clean rooms, vacuums, and low/high temperatures, it may not be possible to use standard grease. In such cases, THK will recommend the optimal lubricant. Please contact THK for details.

Usage environment/ Conditions	Lubrication	THK product
Environments with spattering coolant	<ul style="list-style-type: none"> <li>– To stop the coolant from causing emulsification, use grease that does not easily wash away.</li> <li>– Use grease with extreme pressure and rust-proofing performance.</li> </ul> <p>Note: In environments where water-soluble coolants may spatter, there are occasions where certain types of coolant may cause emulsification or cause the grease to wash away, even if using medium-viscosity lubricant. This, in turn, may then reduce lubricity and prevent a proper oil film from forming. Check the compatibility between the lubricant and coolant.</p> <ul style="list-style-type: none"> <li>● Daphne Super Multi Oil (Idemitsu)</li> <li>● Mobil Vactra Oil No. 2 SLC (Exxon Mobil)</li> </ul>	<ul style="list-style-type: none"> <li>– Please note that applying coolant directly to THK products may have an adverse effect on components/parts made of resin, rubber, etc.</li> <li>– Consider using designs where coolant cannot come into direct contact with THK products (consider using covers or bellows).</li> <li>– Consider using some of the various dust-proofing options available in order to prevent coolant from getting inside THK products.</li> </ul>
High-temperature environment	<ul style="list-style-type: none"> <li>– Please note that the higher the temperature, the greater the risk of the grease separating and the lubrication performance dropping.</li> </ul>	<ul style="list-style-type: none"> <li>– Contact THK for a range of high-temperature specification products.</li> </ul>
Clean room	<ul style="list-style-type: none"> <li>– THK also offers a range of clean room-compatible grease products.</li> </ul> <ul style="list-style-type: none"> <li>● AFE-CA Grease (THK)</li> <li>● AFF Grease (THK)</li> <li>● L100 Grease (THK)</li> </ul>	<ul style="list-style-type: none"> <li>– Two reasons for the generation of dust are metal-to-metal contact and mutual friction between rolling elements. THK offers a range of products with a cage for minimizing metal-to-metal contact and mutual friction between the rolling elements. Furthermore, the cage is also structured in a way that maintains the lubricity, making it suitable for use in clean rooms.</li> <li>– Anti-rust oil is applied as standard, so please specify if it is not required.</li> </ul>
Vacuum environments	<ul style="list-style-type: none"> <li>– Use fluorinated lubricants for vacuums (vapor pressure varies by brand).</li> <li>– Using vacuum grease will make it more likely that the oil film will break due to its low extreme pressure resistance compared to general industrial grease. Be sure that there is a reliable feeding of oil to the raceways (by increasing the number of relubrications, etc.) in order to ensure that the oil film does not break.</li> </ul> <p>Note: If using vacuum greases, please note that some brands have starting resistances several times greater than general-purpose grease.</p>	<ul style="list-style-type: none"> <li>– Please note that under vacuum environments, there is a risk that gas given off by resin and rubber materials may cause the vacuum level to decrease.</li> <li>– Please consider using stainless steel or surface-treated products as a rust-proofing measure.</li> </ul>
High-speed moving parts	<ul style="list-style-type: none"> <li>– Use a lubricant with a low base oil kinematic viscosity to prevent heat generated by resistance from the lubricant.</li> <li>– THK offers a range of grease products with excellent high-speed specifications.</li> </ul> <ul style="list-style-type: none"> <li>● AFA Grease (THK)</li> <li>● AFG Grease (THK)</li> <li>● AFJ Grease (THK)</li> </ul>	<ul style="list-style-type: none"> <li>– Metal-to-metal contact and mutual friction between the rolling elements inside products may produce noise and quickly lead to damage.</li> <li>– THK offers a range of caged products with excellent high-speed and noise-dampening properties.</li> </ul>
Environments with water	<ul style="list-style-type: none"> <li>– Use grease with high water-proofing properties.</li> <li>– Use a lubricant with high extreme pressure resistance that does not easily wash away.</li> </ul> <ul style="list-style-type: none"> <li>● L700 Grease (THK)</li> </ul> <p>– Contact THK for instructions regarding lubricating in and around water.</p>	<ul style="list-style-type: none"> <li>– Consider using designs where water cannot come into contact with THK products. (Consider using bellows or covers.)</li> <li>– Consider using stainless steel or surface-treated products as a rust-proofing measure.</li> <li>– Consider using some of the various dust-proofing options available in order to prevent water from getting inside the product.</li> </ul>
Food machinery	<ul style="list-style-type: none"> <li>– Consider using grease that is made for food processing and that is safe for people.</li> </ul> <ul style="list-style-type: none"> <li>● L700 Grease (THK) (NSF H1 standard accredited)</li> </ul>	<ul style="list-style-type: none"> <li>– Consider using covers if there is the possibility of lubricant spattering.</li> </ul>
Micro-vibration	<ul style="list-style-type: none"> <li>– THK offers a range of grease products that work particularly well under micro-vibrations.</li> </ul> <ul style="list-style-type: none"> <li>● AFC Grease (THK)</li> <li>● AFJ Grease (THK)</li> </ul>	<ul style="list-style-type: none"> <li>– Oil films formed at the points of contact between the rolling elements and raceway are likely to break in environments with micro-vibrations.</li> <li>– By periodically overstroking, the lubricant will form an oil film at the points of contact between the rolling elements and raceway.</li> </ul>

## Lubrication Methods

There are three methods of lubricating LM systems: manual greasing using a grease gun or manual pump, forced greasing with the aid of an automatic pump, and oil-bath lubrication.

To achieve efficient lubrication, it is necessary to mount the grease nipple or the plumbing fixture according to the mounting orientation.

We also stock grease guns, grease nipples, and plumbing fixtures. See **A24-33**–**A24-35**.

(If using the product in any orientation other than horizontal, be sure to let THK know the mounting orientation and the exact position in each LM block where the grease nipple or the plumbing fixture should be attached. For the mounting orientation of the LM Guide, see **A1-12**.)

---

### Manual Lubrication

---

Generally, grease is replenished periodically and fed through the grease nipple provided on the LM system using a grease gun. (Fig.1)

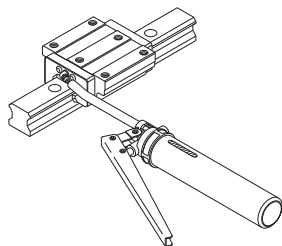

Fig.1 Lubrication using a grease gun

---

### Forced Lubrication Method

---

With this method, a given amount of lubricant is forcibly fed at a given interval. (Fig.2)

Although a special lubrication system using piping or the like needs to be designed, this method reduces the likelihood of forgetting to replenish lubricant.

Use only after making sure that the lubrication oil discharges normally from the ends of the lubrication piping, i.e., the oiling ports that connect to your LM system.

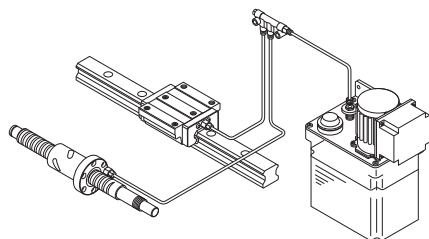

Fig.2 Forced lubrication method

# Lubrication Accessory Series for LM Systems

THK provides a wide array of lubrication accessories such as grease, grease guns, grease nipples and plumbing fixtures available for various applications. (A24-7 to A24-35)

## THK Original Grease

THK provides various types of THK original grease needed for the lubrication of LM systems. They are available for various conditions and environments.

[Table for Grease Selection]

Name of grease	AFA	AFB-LF	AFC	AFE-CA	AFF	AFG
Features	Low sliding friction	All-purpose type	For fretting and corrosion resistance	For clean environments	For clean environments	For preventing heat generation by ball screws
Base oil	High-grade synthetic oil	Refined mineral oil	High-grade synthetic oil	High-grade synthetic oil	High-grade synthetic oil	High-grade synthetic oil
Consistency enhancer	Urea-based	Lithium-based	Urea-based	Urea-based	Lithium-based	Urea-based
Features	Low sliding friction	○	—	—	—	○
	Micro-vibration	○	—	◎	○	○
	High load	—	○	—	—	—
	Low dust generation (Clean environments)	—	—	—	◎	○
	Water resistance	○	○	—	—	○
	Machine stability	—	○	○	○	○
Bellows cartridge color	Clear	Light green	Clear	White	Dark blue	Light green
Cap color	White	Yellow	Orange	White	White	Orange
Reference page	<b>A24-7</b>	<b>A24-9</b>	<b>A24-11</b>	<b>A24-13</b>	<b>A24-15</b>	<b>A24-18</b>

Name of grease	AFJ	L100	L500	L700	
Features	For a wide range of speeds	For clean environments/ High loads	For high-load ball screws	For medical, pharmaceutical, and food equipment	
Base oil	Refined mineral oil	High-grade synthetic oil	Refined mineral oil	High-grade synthetic oil	
Consistency enhancer	Urea-based	Lithium complex-based	Lithium complex-based	Calcium sulfonate complex-based	
Features	Low sliding friction	○	—	—	
	Micro-vibration	○	—	—	
	High load	○	◎	◎	○
	Low dust generation (Clean environments)	—	○	—	—
	Water resistance	—	—	—	◎
	Machine stability	○	○	○	○
Bellows cartridge color	Yellow	Blue	Purple	White	
Cap color	Blue	Yellow	Yellow	White	
Reference page	<b>A24-21</b>	<b>A24-25</b>	<b>A24-27</b>	<b>A24-29</b>	

## THK Original Grease

# AFA Grease

- Base oil: high-grade synthetic oil
- Consistency enhancer: urea-based



AFA Grease is a high-grade grease that possesses a long service life, excellent water resistance, and low sliding resistance through the use of high-grade synthetic oil as the base oil and a urea-based consistency enhancer.

### [Features]

#### (1) Low sliding resistance

As the kinematic viscosity of the base oil is low, it is ideal for long-stroke, high-speed LM Guide operations.

#### (2) Water resistance

It is less vulnerable to moisture penetration than other types of grease because of its high water resistance.

### [Representative Physical Properties]

Item	Representative value	Test method
Consistency enhancer	Urea-based	
Base oil	High-grade synthetic oil	
Base oil kinematic viscosity: mm <sup>2</sup> /s (40°C)	25	JIS K 2220 23
Worked penetration (25°C, 60 W)	285	JIS K 2220 7
Mixing stability (100,000 W)	329	JIS K 2220 15
Dropping point: °C	261	JIS K 2220 8
Evaporation amount: mass% (99°C, 22 h)	0.2	JIS K 2220 10
Oil separation rate: mass% (100°C, 24 h)	0.5	JIS K 2220 11
Copper plate corrosion (B method, 100°C, 24 h)	Accepted	JIS K 2220 9
Low-temperature torque: mN·m (-20°C)	Starting	JIS K 2220 18
	Rotational	
4-ball testing (welding load): N	3089	ASTM D2596
Service temperature range: °C	-45 to 160	
Color	Brown	

### [Sliding Resistance Comparison]

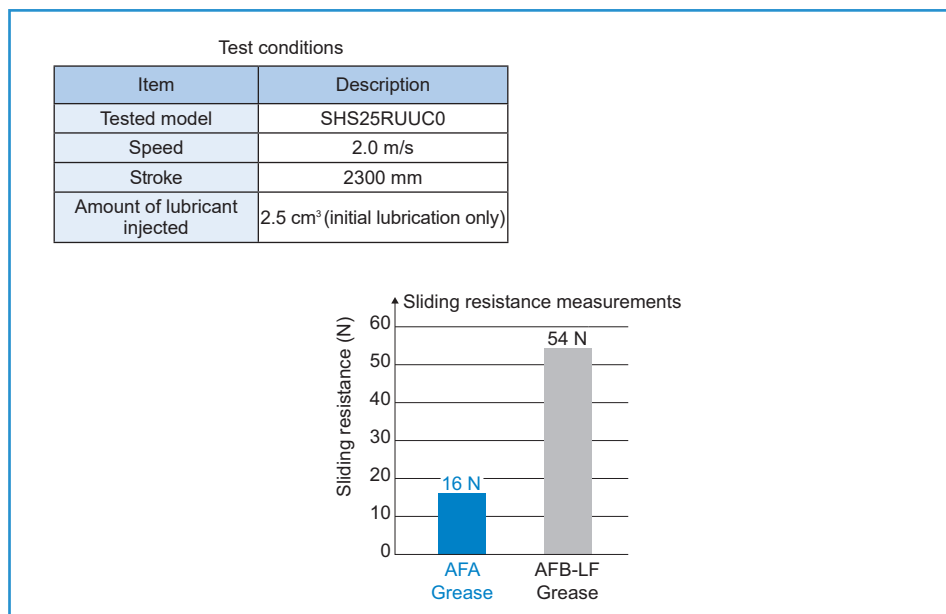

### [Rotational Torque Testing with Ball Screw Grease]

<Test method>

1 cm<sup>3</sup> of grease was applied to the KR4620A + 640L LM Guide and 2 cm<sup>3</sup> to the ball screw (initial injection only), and then the torque was measured at each motor rotation speed. The output values on the driver torque monitor were used for the torque measurements.

Rotational Torque Testing with Electric Actuators

Unit: N·cm

Grease used	Central value of dynamic viscosity mm <sup>2</sup> /s (cSt) (40°C)	Dynamic viscosity range mm <sup>2</sup> /s (cSt) (40°C)	Rotational speed			
			100 min <sup>-1</sup>	1000 min <sup>-1</sup>	2000 min <sup>-1</sup>	4000 min <sup>-1</sup>
AFA Grease	25	22.5 to 27.5	11.3	11.3	12.3	14.6
Lubricating oil VG32	32	28.8 to 35.2	11.2	10.8	13.4	14.7

## THK Original Grease

# AFB-LF Grease

- Base oil: refined mineral oil
- Consistency enhancer: lithium-based



AFB-LF Grease is a general-purpose grease that provides excellent extreme pressure performance and mechanical stability properties through the use of a refined mineral oil base oil and a lithium-based consistency enhancer.

### [Features]

#### (1) Extreme pressure resistance

The action of the special additives provides higher wear resistance and extreme pressure resistance than other lithium-based greases available on the market.

#### (2) Mechanical stability

AFB-LF Grease is not easily softened and demonstrates excellent mechanical stability even when used for a long period of time.

#### (3) Long service life

It provides many times the lubrication life of general lithium soap-based greases. As a result, it offers a lower maintenance workload and greater economy due to the longer intervals between greasing.

### [Representative Physical Properties]

Item	Representative value	Test method
Consistency enhancer	Lithium-based	
Base oil	Refined mineral oil	
Base oil kinematic viscosity: mm <sup>2</sup> /s (40°C)	170	JIS K 2220 23
Worked penetration (25°C, 60 W)	275	JIS K 2220 7
Mixing stability (100,000 W)	345	JIS K 2220 15
Dropping point: °C	193	JIS K 2220 8
Evaporation amount: mass% (99°C, 22 h)	0.4	JIS K 2220 10
Oil separation rate: mass% (100°C, 24 h)	0.6	JIS K 2220 11
Copper plate corrosion (B method, 100°C, 24 h)	Accepted	JIS K 2220 9
Low-temperature torque: mN·m (-20°C)	Starting	JIS K 2220 18
	Rotational	
4-ball testing (welding load): N	3089	ASTM D2596
Service temperature range: °C	-15 to 100	
Color	Brownish yellow	

### [Comparison of Grease Service Life Data]

Test conditions

Item	Description
Test products	HSR25CA1SS+600L
Load	9.8 kN/block
Stroke	350 mm
Speed	30 m/min (max)
Time constant	200 ms
Greasing quantity	4 cm <sup>3</sup> (initial lubrication only)

Travel distance until flaking occurs

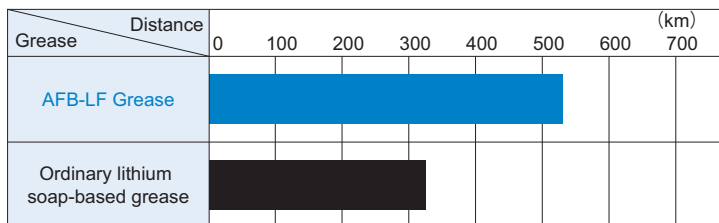

## THK Original Grease

# AFC Grease

- Base oil: high-grade synthetic oil
- Consistency enhancer: urea-based



AFC grease uses high-grade synthetic oil as its base and a urea-based grease as its consistency enhancer, while also featuring special additives. This gives it excellent fretting resistance.

### [Features]

#### (1) Fretting resistance

It is designed to be highly effective in preventing fretting corrosion.

#### (2) Wide temperature range

Since a high-grade synthetic oil is used as the base oil, the lubricating performance remains high over a wide range of temperatures, from  $-54^{\circ}\text{C}$  to  $177^{\circ}\text{C}$ .

### [Representative Physical Properties]

Item	Representative value	Test method
Consistency enhancer	Urea-based	
Base oil	High-grade synthetic oil	
Base oil kinematic viscosity: $\text{mm}^2/\text{s}$ ( $40^{\circ}\text{C}$ )	25	JIS K 2220 23
Worked penetration ( $25^{\circ}\text{C}$ , 60 W)	288	JIS K 2220 7
Mixing stability (100,000 W)	341	JIS K 2220 15
Dropping point: $^{\circ}\text{C}$	269	JIS K 2220 8
Evaporation amount: mass% ( $99^{\circ}\text{C}$ , 22 h)	0.2	JIS K 2220 10
Oil separation rate: mass% ( $100^{\circ}\text{C}$ , 24 h)	0.6	JIS K 2220 11
Copper plate corrosion (B method, $100^{\circ}\text{C}$ , 24 h)	Accepted	JIS K 2220 9
Low-temperature torque: $\text{mN}\cdot\text{m}$ ( $-20^{\circ}\text{C}$ )	Starting	160
	Rotational	68
4-ball testing (welding load): N	3089	ASTM D2596
Service temperature range: $^{\circ}\text{C}$	$-54$ to $177$	
Color	Brown	

## [Fretting Resistance Test Data (Comparison of Raceway Conditions)]

Test conditions

Item	Description
Stroke	3 mm
Number of strokes per minute	200 min <sup>-1</sup>
Total number of strokes	$2.88 \times 10^5$ (24 h)
Surface pressure	1118 MPa
Grease quantity	12 cm <sup>3</sup> (replenished every 8 h)

### AFC Grease

Pre-travel

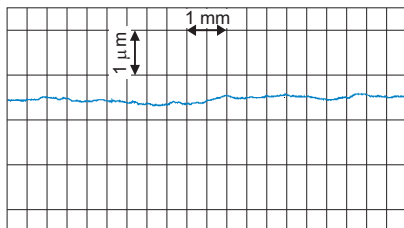

Post-travel

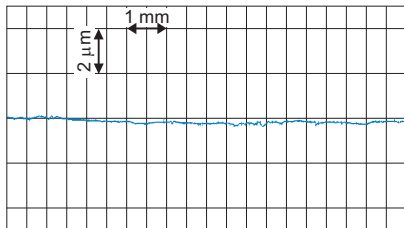

### General bearing grease

Pre-travel

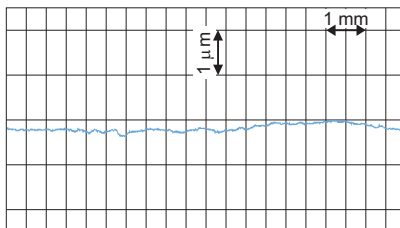

Post-travel

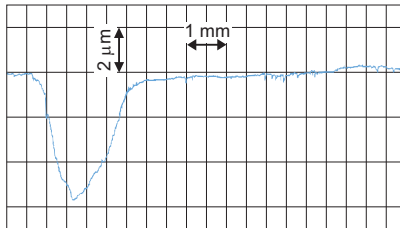

## THK Original Grease

# AFE-CA Grease

- Base oil: high-grade synthetic oil
- Consistency enhancer: urea-based

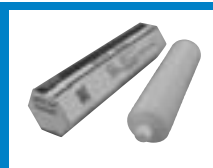

AFE-CA grease uses high-grade synthetic oil as its base and a urea-based grease as its consistency enhancer. This ensures it produces very little dust, making it ideal for use in clean environments.

### [Features]

#### (1) Low dust generation

This grease generates the least amount of dust among all THK low dust-generating grease products. Contains zero metallic elements, making it ideal for use in semiconductor-related fields.

### [Representative Physical Properties]

Item	Representative value	Test method
Consistency enhancer	Urea-based	
Base oil	High-grade synthetic oil	
Base oil kinematic viscosity: mm <sup>2</sup> /s (40°C)	99	JIS K 2220 23
Worked penetration (25°C, 60 W)	280	JIS K 2220 7
Mixing stability (100,000 W)	310	JIS K 2220 15
Dropping point: °C	260	JIS K 2220 8
Evaporation amount: mass% (99°C, 22 h)	0.1	JIS K 2220 10
Oil separation rate: mass% (100°C, 24 h)	0.1	JIS K 2220 11
Copper plate corrosion (B method, 100°C, 24 h)	Accepted	JIS K 2220 9
Low-temperature torque: mN·m (-20°C)	Starting	JIS K 2220 18
	Rotational	
4-ball testing (welding load): N	1236	ASTM D2596
Service temperature range: °C	-40 to 180	
Color	Light yellowish brown	

## [Low Dust-Generating Performance Test Data]

### ● AFE-CA Grease Test Data (Comparison of Dust Generation)

Test conditions

Item	Description
Tested model	SSR20XW1+280L
Grease quantity	1.2 cm <sup>3</sup> (initial lubrication only)
Amount of air supplied	0.3 L/min
Feeding speed	500 mm/s
Stroke	200 mm

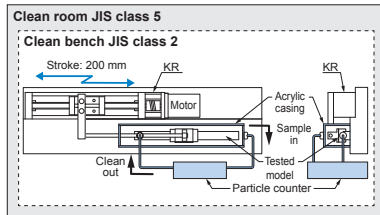

Testing device

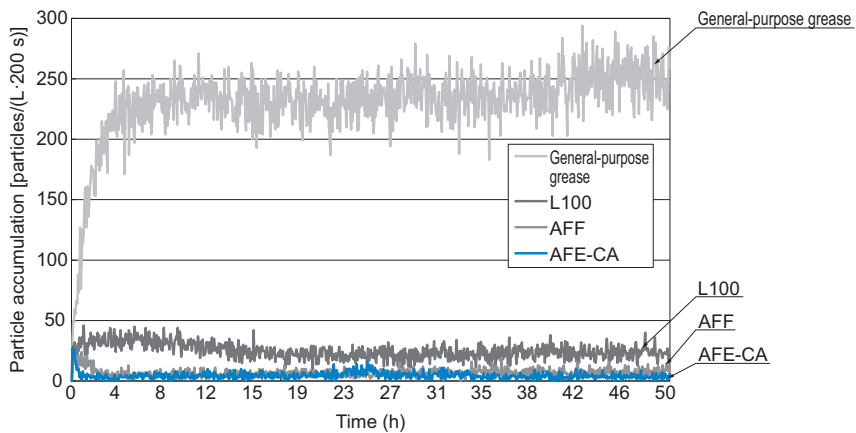

## THK Original Grease

# AFF Grease

- Base oil: high-grade synthetic oil
- Consistency enhancer: lithium-based



AFF grease uses high-grade synthetic oil as its base and a lithium-based grease as its consistency enhancer, while also featuring special additives. This gives it excellent anti-fretting and low dust-generating performance. It also features a level of stable rolling resistance not found in other conventional vacuum and low dust-generating greases.

### [Features]

#### (1) Stable rolling resistance

Since the viscous resistance is low, the rolling resistance fluctuation is also low. Thus, superb conformity is achieved at low speeds.

#### (2) Low dust generation

It generates very little dust, making it ideal for use under micro-stroke conditions.

#### (3) Fretting resistance

Since AFF grease is more resistant to wear from micro-vibrations than other low dust-generating greases, it allows the greasing interval to be extended.

### [Representative Physical Properties]

Item	Representative value	Test method
Consistency enhancer	Lithium-based	
Base oil	High-grade synthetic oil	
Base oil kinematic viscosity: mm <sup>2</sup> /s (40°C)	100	JIS K 2220 23
Worked penetration (25°C, 60 W)	315	JIS K 2220 7
Mixing stability (100,000 W)	345	JIS K 2220 15
Dropping point: °C	220	JIS K 2220 8
Evaporation amount: mass% (99°C, 22 h)	0.7	JIS K 2220 10
Oil separation rate: mass% (100°C, 24 h)	2.6	JIS K 2220 11
Copper plate corrosion (B method, 100°C, 24 h)	Accepted	JIS K 2220 9
Low-temperature torque: mN·m (-20°C)	Starting	JIS K 2220 18
	Rotational	
4-ball testing (welding load): N	1236	ASTM D2596
Service temperature range: °C	-40 to 120	
Color	Reddish brown	

## [Low Dust-Generating Performance Test Data]

### ● AFF Grease Test Data (Comparison of Dust Generation)

Test conditions

Item	Description
Tested model	SSR20XW1+280L
Grease quantity	1.2 cm <sup>3</sup> (initial lubrication only)
Amount of air supplied	0.3 L/min
Feeding speed	500 mm/s
Stroke	200 mm

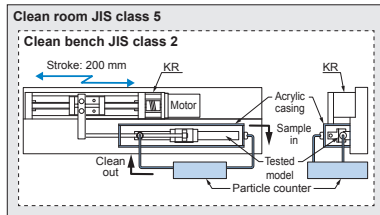

Testing device

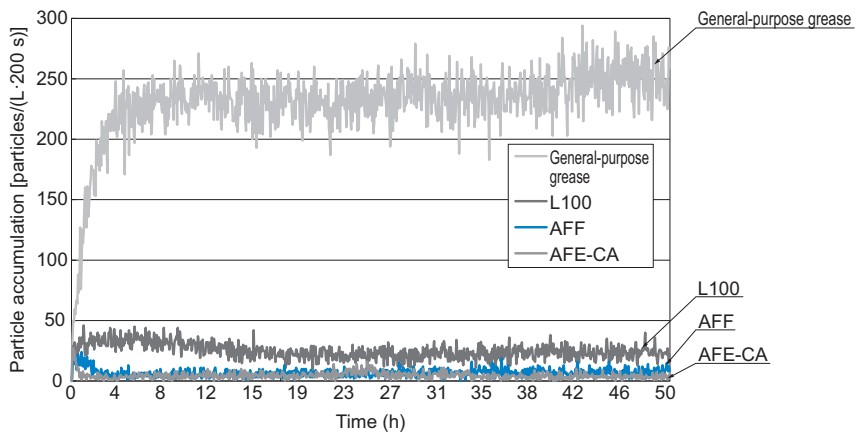

## [Rolling Resistance Characteristics at Low Speed]

Test conditions

Item	Description
Tested model	HSR35RC0+440LP
Grease quantity	4 cm <sup>3</sup> (initial lubrication only)
Feeding speed	1 mm/s
Stroke	3 mm

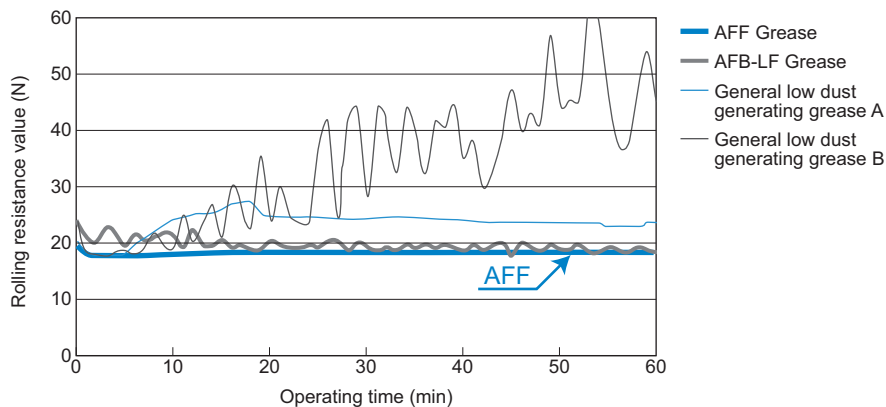

## THK Original Grease

# AFG Grease

- Base oil: high-grade synthetic oil
- Consistency enhancer: urea-based



AFG Grease is a high-grade grease for ball screws that uses high-grade synthetic oil as its base and a urea-based grease as its consistency enhancer. This ensures that it has superior low heat-generating properties, allowing for use over a wide temperature range—from low to high temperatures.

### [Features]

#### (1) Low heat generation

Since the viscous resistance is low, the grease generates only a minimal level of heat even during high-speed operation.

#### (2) Low torque properties

Features a low base oil kinematic viscosity, making it ideal for ball screws.

#### (3) Water resistance

AFG Grease is a highly water-resistant grease that is less vulnerable to softening and reductions in extreme pressure resistance due to moisture penetration.

### [Representative Physical Properties]

Item	Representative value	Test method
Consistency enhancer	Urea-based	
Base oil	High-grade synthetic oil	
Base oil kinematic viscosity: mm <sup>2</sup> /s (40°C)	25	JIS K 2220 23
Worked penetration (25°C, 60 W)	285	JIS K 2220 7
Mixing stability (100,000 W)	329	JIS K 2220 15
Dropping point: °C	261	JIS K 2220 8
Evaporation amount: mass% (99°C, 22 h)	0.2	JIS K 2220 10
Oil separation rate: mass% (100°C, 24 h)	0.5	JIS K 2220 11
Copper plate corrosion (B method, 100°C, 24 h)	Accepted	JIS K 2220 9
Low-temperature torque: mN·m (-20°C)	Starting	JIS K 2220 18
	Rotational	
4-ball testing (welding load): N	3089	ASTM D2596
Service temperature range: °C	-45 to 160	
Color	Brown	

## [Low Heat Generation Test Data]

Test conditions

Item	Description
Tested model	SBN3210-7RRG0+1094LC5 (Pre-load only)
Rotational speed	400 to 3000 min <sup>-1</sup>
Grease quantity	12 cm <sup>3</sup> (initial lubrication only)
Temperature measurement point	Nut outer diameter area

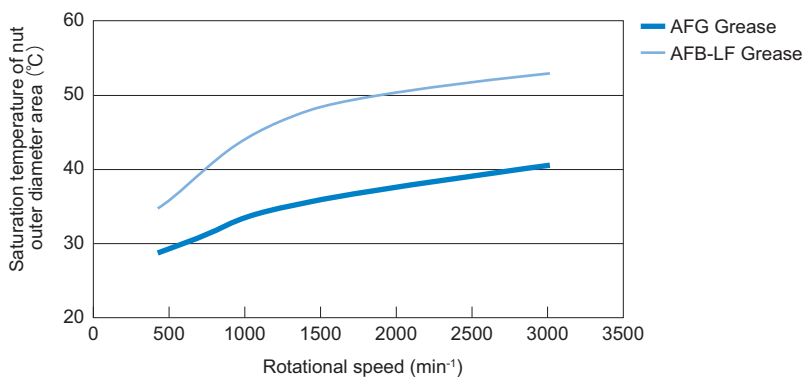

## [Ball Screw Torque Data]

Test conditions

Item	Description
Tested model	SBN3210-7RRG0+1094LC5 (Pre-load only)
Rotational speed	2 to 1200 min <sup>-1</sup>
Amount of lubricant injected	13 cm <sup>3</sup> (initial lubrication only)

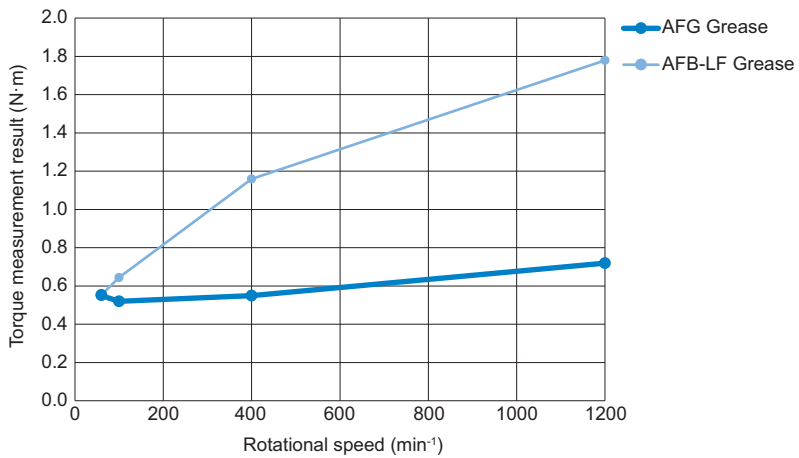

## THK Original Grease

# AFJ Grease

- Base oil: refined mineral oil
- Consistency enhancer: urea-based



AFJ grease uses refined mineral oil as its base and a urea-based grease as its consistency enhancer, while also featuring other special additives. This gives it excellent lubrication properties at a wide range of speeds—from low to high.

### [Features]

#### (1) Wide range of speeds

It provides consistent and even lubrication at a wide range of speeds, from low to high.

#### (2) Wear resistance

Even at low speeds, it has excellent oil film formation to reduce wear.

#### (3) Vibration resistance

It reduces wear caused by machine vibration during high-speed operation.

### [Representative Physical Properties]

Item	Representative value	Test method
Consistency enhancer	Urea-based	
Base oil	Refined mineral oil	
Base oil kinematic viscosity: mm <sup>2</sup> /s (40°C)	20	JIS K 2220 23
Worked penetration (25°C, 60 W)	325	JIS K 2220 7
Mixing stability (100,000 W)	360	JIS K 2220 15
Dropping point: °C	185	JIS K 2220 8
Evaporation amount: mass% (99°C, 22 h)	0.6	JIS K 2220 10
Oil separation rate: mass% (100°C, 24 h)	7.0	JIS K 2220 11
Copper plate corrosion (B method, 100°C, 24 h)	Accepted	JIS K 2220 9
Low-temperature torque: mN·m (-20°C)	Starting	JIS K 2220 18
	Rotational	
4-ball testing (welding load): N	3089	ASTM D2596
Service temperature range: °C	-20 to 120	
Color	Yellowish brown	

## [Wear Resistance Test Data (LM Guide Block)]

Test conditions

Item	Description
Tested model	NRS55B2SS+780LP
Applied load	5.9 kN
Feeding speed	0.1 m/min
Stroke	200 mm
Grease quantity	12 cm <sup>3</sup> (initial lubrication only)
Test duration	480 h

### AFJ Grease

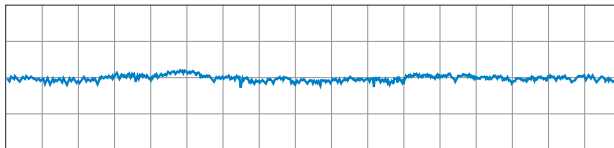

### Other urea-based grease

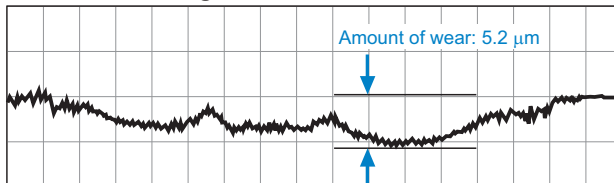

## [Vibration Resistance Test Data (LM Guide Rail)]

Test conditions

Item	Description
Tested model	SHS25R1UU+580LP
Applied load	11.05 kN (0.35C)
Feeding speed	60 m/min
Acceleration/ deceleration	9.8 m/s <sup>2</sup>
Stroke	350 mm
Grease quantity	2 cm <sup>3</sup> (initial lubrication only)

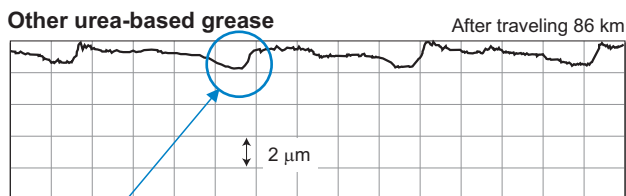
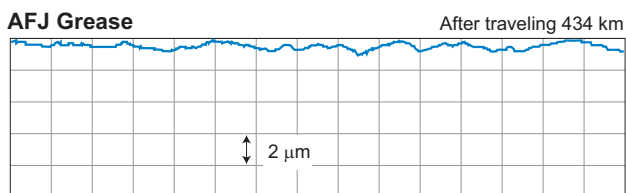

**“Wear  
mechanism”**

High-speed  
movement and  
rapid acceleration/  
deceleration

Mechanical  
vibrations  
occur

Raceways  
wear down

## [LM Guide Rolling Resistance Measurement Data]

Test conditions

Item	Description
Tested model	SHS25R1UU+3000L
Applied load	No load
Acceleration	29.4 m/s <sup>2</sup> (3G)
Stroke	2300 mm
Test temperature	21°C
Grease quantity	2 cm <sup>3</sup> (initial lubrication only)
Measurement speed	0.5, 1, 2, 3, 4, 5, 6 m/s

### LM Guide speed and rolling resistance

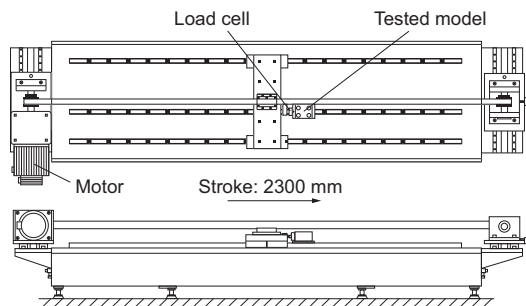
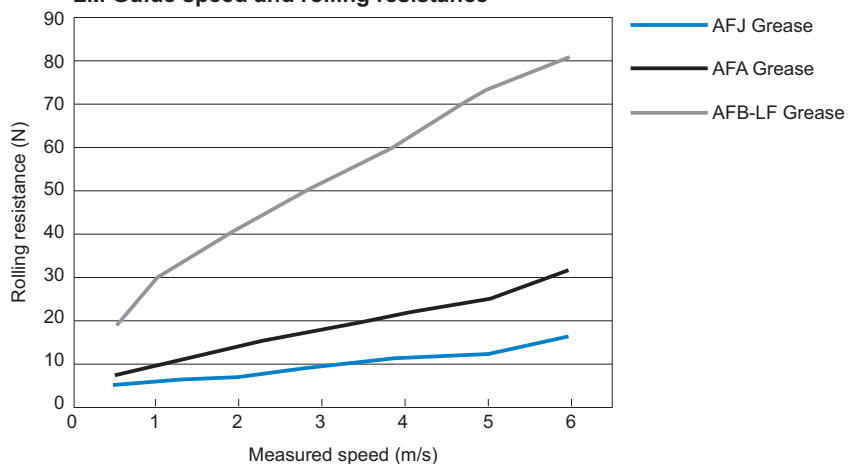

## THK Original Grease

# L100 Grease

- Base oil: high-grade synthetic oil
- Consistency enhancer: lithium complex-based



L100 grease uses high-grade synthetic oil as its base and lithium complex-based grease as its consistency enhancer, while also featuring special additives. It also produces little dust and boasts excellent extreme pressure resistance to a degree not found in standard low dust-generating greases. This makes it ideal for use in clean rooms.

Note: This product cannot be used in Europe.

### [Features]

#### (1) Low dust generation

It demonstrates the same low dust-generating performance as our previous low dust-generating grease, making it ideal for use in clean rooms.

#### (2) Extreme pressure resistance

The action of the additives and base oil (which is suitable for withstanding loads) gives it extreme pressure resistance three times greater than our previous low dust-generating grease.

### [Representative Physical Properties]

Item	Representative value	Test method
Consistency enhancer	Lithium complex-based	
Base oil	High-grade synthetic oil	
Base oil kinematic viscosity: mm <sup>2</sup> /s (40°C)	198	JIS K 2220 23
Worked penetration (25°C, 60 W)	294	JIS K 2220 7
Mixing stability (100,000 W)	312	JIS K 2220 15
Dropping point: °C	260	JIS K 2220 8
Evaporation amount: mass% (99°C, 22 h)	0.1	JIS K 2220 10
Oil separation rate: mass% (100°C, 24 h)	0.8	JIS K 2220 11
Copper plate corrosion (B method, 100°C, 24 h)	Accepted	JIS K 2220 9
Low-temperature torque: mN·m (-20°C)	Starting	JIS K 2220 18
	Rotational	
4-ball testing (welding load): N	3922	ASTM D2596
Service temperature range: °C	-40 to 150	
Color	Yellow	

## [Low Dust-Generating Performance Test Data]

### ● Comparison with other THK greases

Test conditions

Item	Description
Tested model	SSR20XW1
Grease quantity	1.2 cm <sup>3</sup> (initial lubrication only)
Amount of air supplied	0.3 L/min
Feeding speed	500 mm/s
Stroke	200 mm

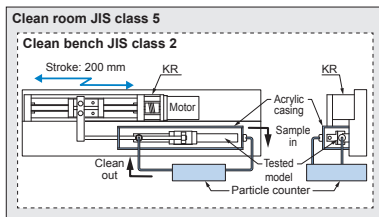

Testing device

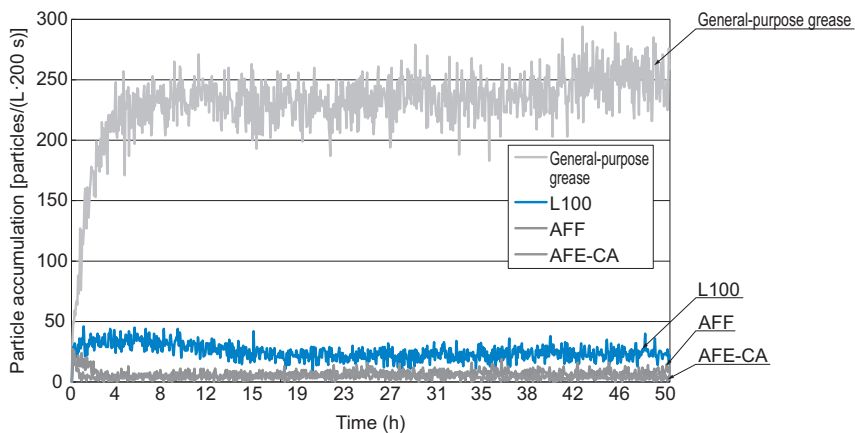

## [Extreme Pressure Resistance]

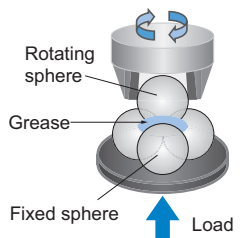

Testing apparatus

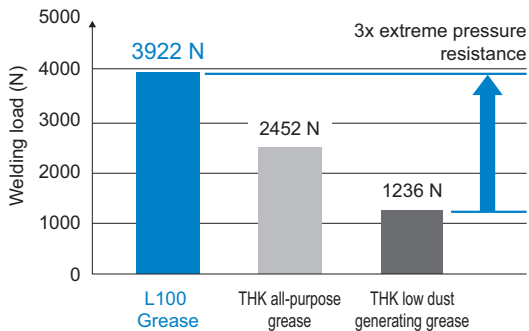

## THK Original Grease

# L500 Grease

- Base oil: refined mineral oil
- Consistency enhancer: lithium complex-based



L500 grease uses refined mineral oil as its base and lithium complex-based grease as its consistency enhancer, while also featuring special additives. It features excellent extreme pressure resistance and pumpability as well as a long service life.

Note: This product cannot be used in Europe.

### [Features]

#### (1) Extreme pressure resistance

The action of the special additives gives it excellent extreme pressure resistance.

#### (2) Long service life

It provides longer lasting lubrication than general high-load grease, helping reduce the amount of time spent on maintenance.

#### (3) Pumpability

It boasts excellent pumpability, allowing it to be used with automatic lubricating systems.

### [Representative Physical Properties]

Item	Representative value	Test method
Consistency enhancer	Lithium complex-based	
Base oil	Refined mineral oil	
Base oil kinematic viscosity: mm <sup>2</sup> /s (40°C)	120	JIS K 2220 23
Worked penetration (25°C, 60 W)	327	JIS K 2220 7
Mixing stability (100,000 W)	365	JIS K 2220 15
Dropping point: °C	250	JIS K 2220 8
Evaporation amount: mass% (99°C, 22 h)	0.4	JIS K 2220 10
Oil separation rate: mass% (100°C, 24 h)	2.5	JIS K 2220 11
Copper plate corrosion (B method, 100°C, 24 h)	Accepted	JIS K 2220 9
Low-temperature torque: mN·m (-20°C)	Starting	JIS K 2220 18
	Rotational	
4-ball testing (welding load): N	4903	ASTM D2596
Service temperature range: °C	-20 to 175	
Color	Yellow	

### [Extreme Pressure Resistance]

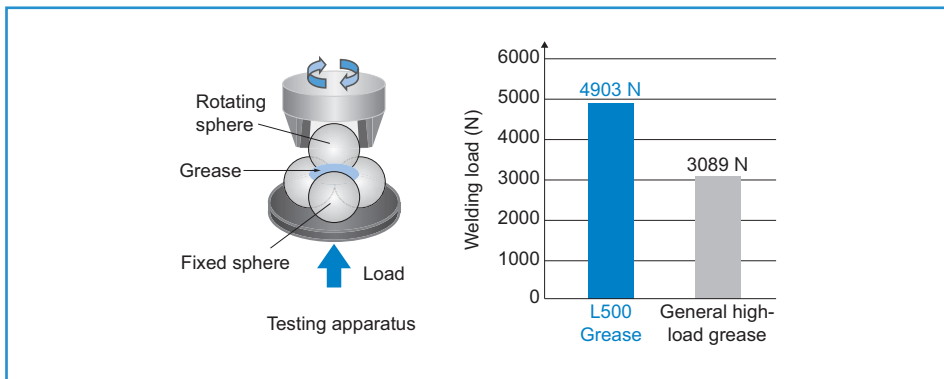

### [Long Service Life]

#### ● Lubrication service life measured via ball screw

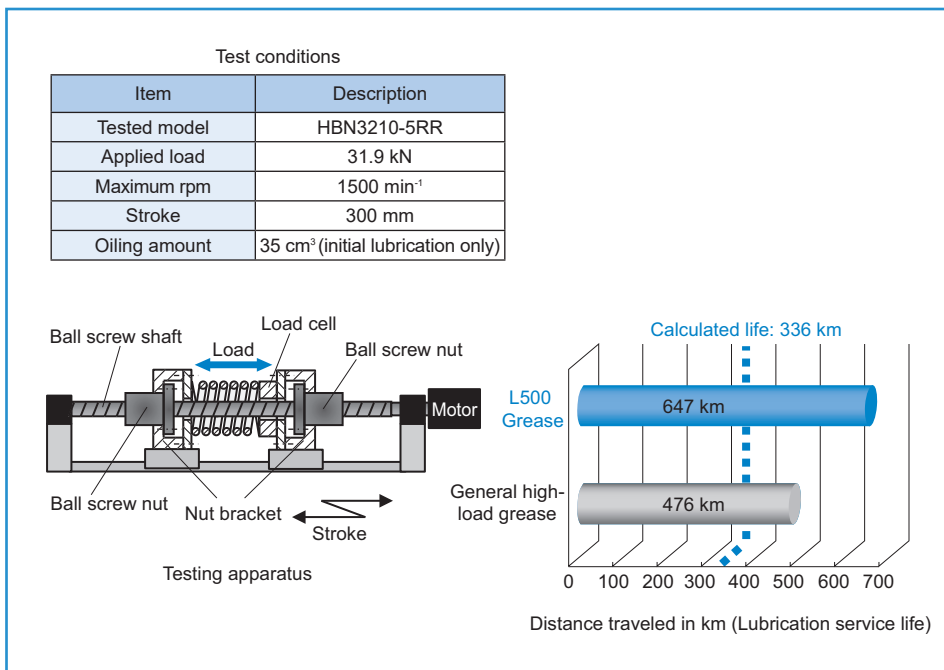

## THK Original Grease

# L700 Grease

- Base oil: high-grade synthetic oil
- Consistency enhancer: calcium sulfonate complex-based



L700 Grease is an H1 grease product certified and registered by NSF International.<sup>1</sup> Using a high-grade synthetic oil as the base oil in conjunction with a calcium sulfonate complex-based consistency enhancer, L700 Grease maintains excellent water and corrosion resistance and withstands extreme pressure. It is intended for use in medical, pharmaceutical, and food equipment.

<sup>1</sup> A third party certification body for matters related to public safety and health

Note: This product cannot be used in Europe.

### [Features]

#### (1) NSF-certified

L700 Grease is an H1 grease product certified and registered by NSF International (NSF H1).

#### (2) Water and corrosion resistance

Calcium sulfonate (the consistency enhancer) makes L700 Grease more resistant to water and corrosion than ordinary H1 grease.

#### (3) Extreme pressure resistance

L700 Grease displays better extreme pressure resistance than general-purpose grease.

### [Representative Physical Properties]

Item	Representative value	Test method
Consistency enhancer	Calcium sulfonate complex-based	
Base oil	High-grade synthetic oil	
Base oil kinematic viscosity: mm <sup>2</sup> /s (40°C)	89	JIS K 2220 23
Worked penetration (25°C, 60 W)	314	JIS K 2220 7
Mixing stability (100,000 W)	324	JIS K 2220 15
Dropping point: °C	250	JIS K 2220 8
Evaporation amount: mass% (99°C, 22 h)	0.15	JIS K 2220 10
Oil separation rate: mass% (100°C, 24 h)	2.9	JIS K 2220 11
Copper plate corrosion (B method, 100°C, 24 h)	Accepted	JIS K 2220 9
Low-temperature torque: mN·m (-20°C)	Starting	JIS K 2220 18
	Rotational	
4-ball testing (welding load): N	3922	ASTM D2596
Service temperature range: °C	-40 to 200	
Color	Tan	

**[Water Resistance]**

- Leakage comparison with ordinary H1 grease by rotating a bearing containing grease mixed with 10 mass% of water

## Test conditions

Item	Description
Bearing	JIS B 1521 6204, Open type, Class 0, C3 clearance
Water content	10% of the grease weight
Rpm	600 min <sup>-1</sup>
Test duration	60 min

## Test result



L700 Grease



Ordinary H1 grease

**[Low Sliding Resistance]**

- Measurement of sliding resistance when an LM Guide is injected with grease and operated at low speed to high speed

Test conditions

Item	Description
Tested model	SHS25
Measurement speed	0.1 to 3.0 m/s
Acceleration	29.4 m/s <sup>2</sup> (3G)
Stroke	2300 mm

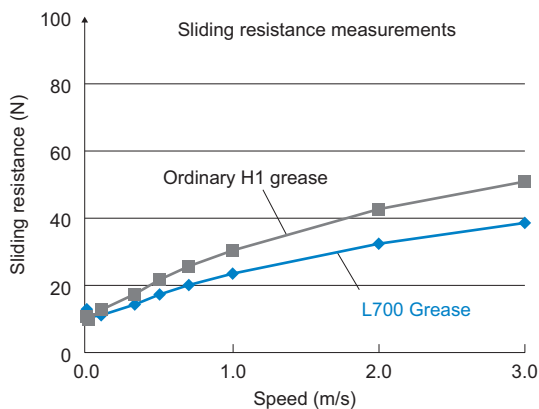
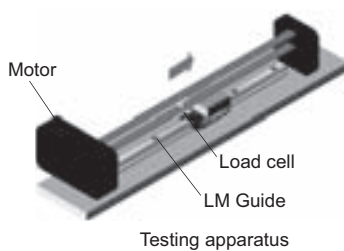

### [Extreme Pressure Resistance]

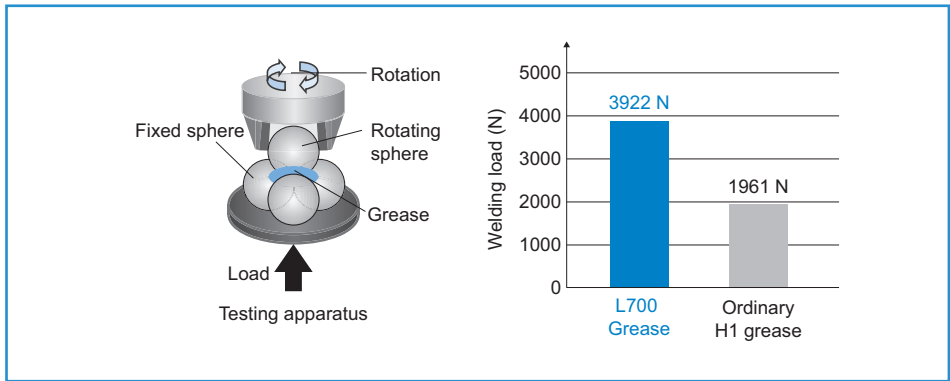

### [Low-Temperature Characteristics]

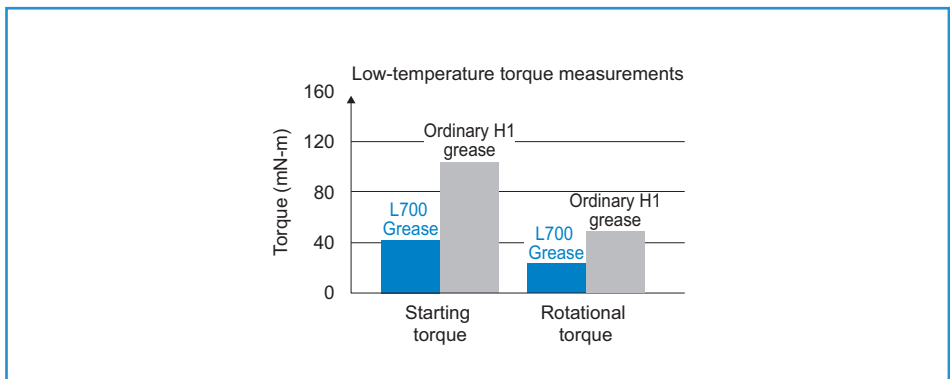

## Lubrication Equipment

# Grease Gun Unit MG70

- Discharge pressure: 19.6 MPa max
- Discharge rate: 0.6 cm<sup>3</sup>/stroke
- Grease: 70 g/80 g bellows cartridge
- Overall length: 235 mm (excluding the nozzle)
- Weight: 480 g (including the nozzle, excluding the grease)



The MG70 grease gun unit is designed especially for use with 70 g and 80 g bellows cartridges. It allows the user to grease the insides of products without dirtying their hands.

The grease gun features a slit window, allowing the user to check the remaining amount of grease.

### [How to Lubricate]

- (1) Depending on the product that you wish to grease, attach either the Type H or dedicated Type U nozzle to the grease gun unit. You can then also install one of the tip attachments (Type N, Type P, or Type L) to the Type U nozzle.
- (2) Push the tip of the grease gun into the grease nipple and apply the grease in a way that ensures it does not protrude out from the side.

### [Supported Model Numbers]

Unit: mm

Type	Dimensions	Supported model numbers	
Type N		LM Guide	Models SSR15, SHS15, SR15, HSR12, HSR15, CSR15, HRW17, GSR15, SRS15G, RSR15M1, HCR12, and HCR15
		Cam Follower	Models CF, CFN-A, and CF-SFU
		Rod End	Models PHS5 to 22 and POS8 to 22
Type P		LM Guide	Models HSR8, HSR10, HRW12, HRW14, and RSR12M1
		Cam Follower	Models CF-AB, CFH-AB, and NUCF-AB
Type L		LM Guide	Models HSR8, HSR10, HRW12, HRW14, and RSR12M1
Type H		LM Guide	Models with grease nipple M6F or PT1/8
		Ball Screw	
		Rod End	Models PHS25, PHS30, POS25, and POS30
Dedicated Type U nozzle		—	—

Note: Types P and L are also capable of greasing less accessible areas for model numbers other than those listed above (by dripping grease on the raceway).

### Model number coding

## MG70

Dedicated grease gun for 70 g and 80 g grease bellows cartridges

In addition to the grease gun unit, this also comes with a dedicated Type U nozzle, dedicated attachments (Type N, Type P, and Type L) and the Type H. Note: Please contact THK regarding grease guns that use 400 g cartridges.

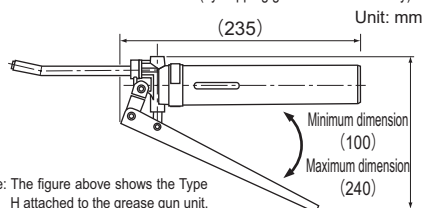

## Accessories for Lubrication

## Special Plumbing Fixtures

We offer a range of special plumbing fixtures that are required for centralized greasing and oil lubrication.

LF-A  
LF-B  
LF-E

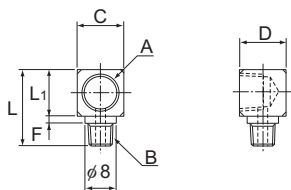

Unit: mm

Model	A Screw (female thread)	B Screw (male thread)	L	L1	F	C	D
LF-A	Rc1/8 (PT1/8)	M6×0.75	20	12	2	12	12
LF-B	M8×1	M6×0.75	18.5	10	2.5	9.5	18
LF-E	Rc1/8 (PT1/8)	M6×1	20	12	2	12	12

LF-C  
LF-D

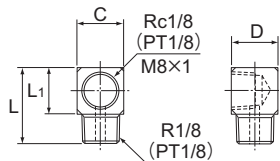

Unit: mm

Model	Screw	L	L1	C	D
LF-C	Rc1/8 (PT1/8)	20	12	12	12
LF-D	M8×1	18	10	10	18

SF-A  
SF-B  
SF-E

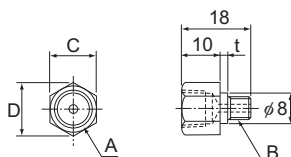

Unit: mm

Model	A Screw (female thread)	B Screw (male thread)	t	C	D
SF-A	Rc1/8 (PT1/8)	M6×0.75	2	12	13.8
SF-B	M8×1	M6×0.75	2	10	11.5
SF-E	Rc1/8 (PT1/8)	M6×1	2	12	13.8

SF-C  
SF-D

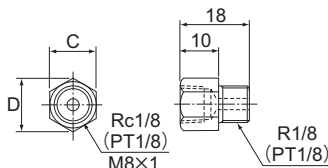

Unit: mm

Model	Screw	C	D
SF-C	Rc1/8 (PT1/8)	12	13.8
SF-D	M8×1	10	11.5

LD

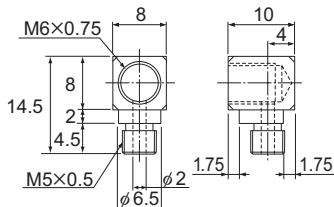

Unit: mm

Model	Screw
LD	M6×0.75

Note: Ensure that you do not overtighten or loosen any attached special plumbing fixtures. Doing so may impair functionality.

## Accessories for Lubrication

# Grease Nipple

We offer various types of grease nipples required for the lubrication of various THK products.

A-M4×0.7 type (M4×0.7) <sup>1</sup>

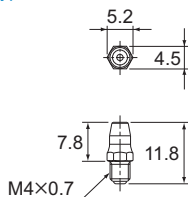

B-M4×0.7 type (M4×0.7) <sup>1</sup>

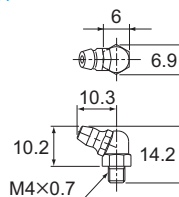

A-M5×0.8 type (M5×0.8) <sup>2</sup>

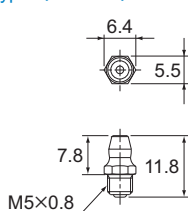

B-M5×0.8 type (M5×0.8) <sup>2</sup>

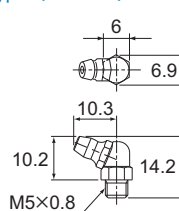

A-MT6×1 type (MT6×1)  
A-M6F type (M6×0.75)

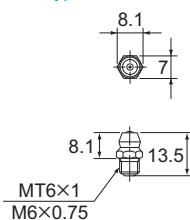

B-MT6×1 type (MT6×1)  
B-M6F type (M6×0.75)

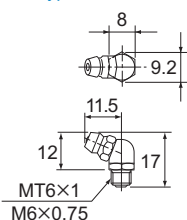

C-MT6×1 type (MT6×1)  
C-M6F type (M6×0.75)

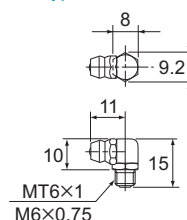

A-PT1/8 type

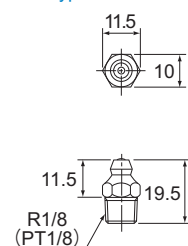

B-PT1/8 type

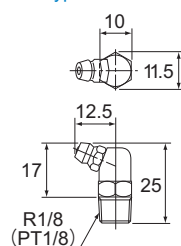

C-PT1/8 type

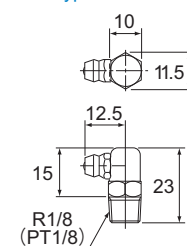

<sup>1</sup> Can be used with products that use Grease Nipple Model PB107 as standard. Contact THK if desired.

<sup>2</sup> Can be used with products that use Grease Nipple Model PB1021B as standard. Contact THK if desired.

Note: Ensure that you do not overtighten or loosen any attached grease nipple. Doing so may impair functionality.

PB107 type

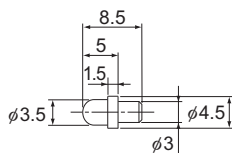

NP3.2×3.5 type

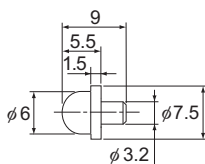

PB1021B type

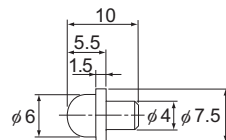

NP6×5 type

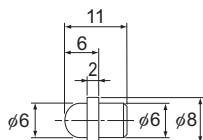

NP8×9 type

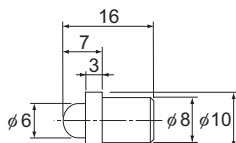

Note: Ensure that you do not overtighten or loosen any attached grease nipple. Doing so may impair functionality.

## Grease Volume by Product

Name of grease	L100	L500	L700	AFA	AFB-LF	AFC	AFE-CA	AFF	AFG	AFJ
Volume by product <sup>1</sup>	80 g 400 g 16 kg	80 g 400 g 16 kg	80 g 400 g	70 g 400 g 16 kg	70 g 400 g 16 kg	70 g 400 g 16 kg	70 g 400 g 18 kg	70 g 400 g 16 kg	70 g 400 g 16 kg	70 g 400 g 16 kg

<sup>1</sup> The 70 g, 80 g, and 400 g types come in bellows cartridges. The 16 kg and 18 kg types come in 18-liter cans.

### Model number coding

- L100, L500, and L700 Grease

**L100 GREASE + 80G**

Cartridge capacity (80 g/400 g/16 kg)

Type of grease (L100, L500, or L700)

- AFA, AFB-LF, AFC, AFE-CA, AFF, AFG, and AFJ Grease

**AFC + 70G**

Cartridge capacity (70 g/400 g/16 kg/18 kg)

Type of grease (AFA, AFB-LF, AFC, AFE-CA, AFF, AFG, or AFJ)

# Glossary

Term	Description																		
Base oil	Base oil is the base ingredient of lubricating oil and grease. It is the component that determines features such as the viscosity of the lubricant. Mineral oil obtained by refining crude oil includes paraffin-based and naphthene-based oils. Synthetic oils obtained by chemical synthesis can also be used as the base ingredient of synthetic lubricants.																		
Consistency enhancer	Consistency enhancers are used to turn base oils semi-solid. They can be broadly split into two types, namely soap-based types and non-soap-based types. (1) Soap-based types: Calcium, sodium, or lithium salts from high-grade fatty acids—the main components of animal fats and oils—are the most commonly used consistency enhancers. There are also some that use complex soaps as consistency enhancers. (2) Non-soap-based types: For greases that require heat resistance, there are types that use inorganic matter such as bentone or silica gel as the main component, and types that use organic matter with heat-resistant properties such as urea compounds and fluorine compounds. These tend to be used more than soap-based types in high operating temperatures, as they contain no metallic elements and will not oxidize metal parts.																		
Additives	Additives are used for improving special functions required of the grease. These can be added, as required, in the same way as general-use lubricants, and they include antioxidants, rust-proofing agents, extreme pressure agents, oiling agents, structural stability agents, and solid lubricants.																		
Lithium soap-based grease (Soap-based grease)	Lithium soap-based grease is a general-purpose grease used for the widest range of products and applications. It is used in general industries, automobiles, various types of bearings, and home appliances. Using mineral oil or synthetic oil in conjunction with a lithium soap with hydrogenated fatty acid-derived castor oil or lithium stearate as a consistency enhancer allows for use over a wide temperature range and provides excellent water resistance and shear stability properties.																		
Lithium complex grease (Soap-based grease)	Lithium complex grease uses soap such as that made by reacting fatty acids and dibasic acid with lithium hydroxide as a consistency enhancer. This gives a dropping point of at least 260°C, and excellent heat, water, and corrosion resistance. It can be used under higher temperatures than lithium grease.																		
Urea grease (Non-soap-based grease)	Urea grease is a grease containing organic compounds with two or more urea groups (-NH-CO-NH-) that is generally used as a consistency enhancer. Its excellent heat and water resistance allows it to be used in everything from rolling mills to continuous casting equipment for steel manufacturers. Urea grease is a common non-soap-based grease. It is also widely used in automobiles and electrical components.																		
Base oil kinematic viscosity (JIS K 2220 23)	The base oil kinematic viscosity represents the viscosity of the base oil. Its value is derived from measuring the magnitude of the internal resistance of the base oil. The higher the base oil kinematic viscosity, the higher the viscosity level. The smaller the value, the lower the viscosity level. For lubricating oils, the SI units are expressed in terms of mm <sup>2</sup> /s (40°C) = cSt. cSt (=1 × 10 <sup>-6</sup> m <sup>2</sup> /s) is also generally used.																		
Worked penetration (JIS K 2220 7)	The worked penetration represents the hardness of the grease. The higher the worked penetration value, the more pliable the grease. The lower the value, the harder the grease. This consistency level is obtained directly after keeping the grease at 25°C with a regulated mixer and then mixing it back and forth 60 times. NLGI <sup>1</sup> consistency numbers are classified according to the worked penetration value. <sup>1</sup> NLGI: National Lubricating Grease Institute NLGI No. and Worked Penetration Value <table border="1"> <thead> <tr> <th>NLGI No.</th> <th>Worked penetration</th> <th>Status</th> </tr> </thead> <tbody> <tr> <td>No.00</td> <td>400 to 430</td> <td>Semi-fluid state</td> </tr> <tr> <td>No.0</td> <td>355 to 385</td> <td>Extremely pliable</td> </tr> <tr> <td>No.1</td> <td>310 to 340</td> <td>Pliable</td> </tr> <tr> <td>No.2</td> <td>265 to 295</td> <td>Moderate</td> </tr> <tr> <td>No.3</td> <td>220 to 250</td> <td>Slightly hard</td> </tr> </tbody> </table>	NLGI No.	Worked penetration	Status	No.00	400 to 430	Semi-fluid state	No.0	355 to 385	Extremely pliable	No.1	310 to 340	Pliable	No.2	265 to 295	Moderate	No.3	220 to 250	Slightly hard
NLGI No.	Worked penetration	Status																	
No.00	400 to 430	Semi-fluid state																	
No.0	355 to 385	Extremely pliable																	
No.1	310 to 340	Pliable																	
No.2	265 to 295	Moderate																	
No.3	220 to 250	Slightly hard																	
Mixing stability (JIS K 2220 15)	Mixing stability represents the mechanical stability of grease. This consistency is obtained by working the grease 100,000 times with a regulated mixer, keeping it at 25°C, and then mixing another 60 times.																		

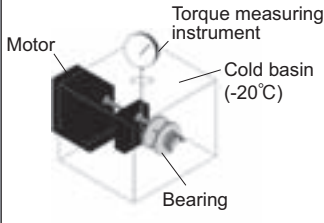
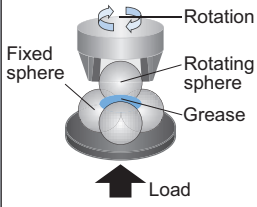
Term	Description
Dropping point (JIS K 2220 8)	The dropping point represents the temperature at which grease melts and begins to flow. (It is not the operating temperature limit.) It serves as a guide for heat resistance.
Evaporation amount (JIS K 2220 10)	The evaporation amount represents the volume of oil in the grease lost to evaporation when the grease is exposed to high temperatures. If there is a high volume of oil lost to evaporation when used under high-temperature conditions, the grease becomes more likely to harden and thus may become ineffective as a lubricant. The evaporation amount is calculated by leaving the grease in a bath at a specified temperature (99°C) for 22 hours and then comparing the volume both before and after the test.
Oil separation rate (JIS K 2220 11)	The oil separation rate represents the level of oil floating on the surface of the grease when the grease is left for a long period. When heat and force (gravity, pressure, and centrifugal forces) act upon grease, the consistency enhancer becomes unable to hold the base oil and partially separates from it. This phenomenon is called oil separation. High levels of separation impact the life of mechanical components due to depletion of the lubricant.
Copper plate corrosion (JIS K 2220 9)	Copper plate corrosion is determined by immersing a copper plate in grease, and then checking whether the copper plate changes color or not after it is left at a specified temperature for a set length of time. It is mainly a guide for determining the presence of corrosive sulfur.
Low-temperature torque (JIS K 2220 18)	<p>Low-temperature torque represents the increased torque of bearings when grease becomes hard in low temperatures. The starting and rotational torque of bearings are measured in low-temperature baths; the lower the value, the greater the fluidity in low temperatures.</p> 
4-ball testing (Welding load) (ASTM D2596)	<p>4-ball testing (welding load) indicates the level of load-bearing capacity for grease. Four steel balls with the same dimensions are used to build a pyramid shape, the bottom three balls are fixed together and immersed in the sample solution, and the top ball is pressed down and rotated.</p> 
Viscosity index	The viscosity index represents the relationship between the viscosity and temperature of grease. The greater the value, the less change in viscosity due to temperature.
Oxidation stability	The oxidation stability indicates the levels of oxidative degradation when grease reacts with oxygen in the air. The oxidation causes the grease to become more likely to liquefy as the consistency enhancer becomes unable to maintain the base oil. It also causes increased viscosity of the base oil and the generation of corrosive substances, etc. The value is obtained by heating the grease to 99°C within a cylinder at an oxygen pressure of 0.755 MPa, recording the pressure drops at set intervals, and then measuring how much the pressure has decreased after 100 hours.



# Accessories for Lubrication

THK General Catalog

## B Support Book

<b>Lubrication</b> .....	B 24-2
Types of Lubricants .....	B 24-2
• Grease Lubrication .....	B 24-3
• Oil Lubrication .....	B 24-3
Product Selection According to Usage Environment ..	B 24-4
Lubrication Methods .....	B 24-5
• Manual Lubrication .....	B 24-5
• Forced Lubrication Method .....	B 24-5
Lubrication Accessory Series for LM Systems ..	B 24-6
• THK Original Grease .....	B 24-6
AFA Grease .....	B 24-7
AFB-LF Grease .....	B 24-9
AFC Grease .....	B 24-11
AFE-CA Grease .....	B 24-13
AFF Grease .....	B 24-15
AFG Grease .....	B 24-18
AFJ Grease .....	B 24-21
L100 Grease .....	B 24-25
L500 Grease .....	B 24-27
L700 Grease .....	B 24-29
Grease Gun Unit MG70 .....	B 24-33
Special Plumbing Fixtures .....	B 24-33
Grease Nipple .....	B 24-33
Grease Volume by Product .....	B 24-34
Glossary .....	B 24-35

## A Product Descriptions (Separate)

<b>Lubrication</b> .....	A 24-2
Types of Lubricants .....	A 24-2
• Grease Lubrication .....	A 24-3
• Oil Lubrication .....	A 24-3
Product Selection According to Usage Environment ..	A 24-4
Lubrication Methods .....	A 24-5
• Manual Lubrication .....	A 24-5
• Forced Lubrication Method .....	A 24-5
Lubrication Accessory Series for LM Systems ..	A 24-6
• THK Original Grease .....	A 24-6
AFA Grease .....	A 24-7
AFB-LF Grease .....	A 24-9
AFC Grease .....	A 24-11
AFE-CA Grease .....	A 24-13
AFF Grease .....	A 24-15
AFG Grease .....	A 24-18
AFJ Grease .....	A 24-21
L100 Grease .....	A 24-25
L500 Grease .....	A 24-27
L700 Grease .....	A 24-29
Grease Gun Unit MG70 .....	A 24-33
Special Plumbing Fixtures .....	A 24-34
Grease Nipple .....	A 24-35
Grease Volume by Product .....	A 24-36
Glossary .....	A 24-37

To optimize an LM system's functionality, it is necessary to provide lubrication according to the usage conditions. Use without lubrication may increase wear on the rolling elements and shorten the service life.

Lubrication has the following effects:

- (1) Minimizes friction between moving elements to prevent seizure and reduce wear
- (2) Forms an oil film on the raceway to decrease stress acting on the surface and extend rolling fatigue life
- (3) Covers metal surfaces with an oil film to prevent the formation of rust

Even when the LM system has seals, the internal lubricant gradually seeps out during operation. Therefore, the system needs to be lubricated at an appropriate interval according to the usage conditions.

## Types of Lubricants

LM systems mainly use grease or sliding surface oil for their lubricants.

The requirements that lubricants need to satisfy generally consist of the following:

- (1) Extreme pressure resistance
- (2) Reduce friction
- (3) High wear resistance
- (4) High thermal stability
- (5) Excellent rust-proofing performance
- (6) Excellent fluidity
- (7) Consistency of grease must not vary significantly even with repeated stirring

## Grease Lubrication

Greasing intervals vary depending on the usage environment and conditions. For normal use, we recommend greasing the system approximately every 100 km of travel distance (3 to 6 months). When replenishing grease through the LM system's grease nipple and lubrication hole, use grease of the same type. Mixing different types of grease may hinder the system's performance.

Lubricant	Type	Brand name
Grease	Lithium-based grease Urea-based grease Calcium-based grease	AFA Grease see <a href="#">B24-7</a> AFB-LF Grease see <a href="#">B24-9</a> AFC Grease see <a href="#">B24-11</a> AFE-CA Grease see <a href="#">B24-13</a> AFF Grease see <a href="#">B24-15</a> AFG Grease see <a href="#">B24-18</a> AFJ Grease see <a href="#">B24-21</a> L100 Grease see <a href="#">B24-25</a> L500 Grease see <a href="#">B24-27</a> L700 Grease see <a href="#">B24-29</a>  Shell Alvania Grease S (Showa Shell Sekiyu) Daphne Eponex Grease MP (Idemitsu) Equivalent product

Note: The recommended grease will vary according to the usage conditions and environment.

## Oil Lubrication

Lubricant	Type	Brand name
Oil	Sliding surface oil or turbine oil ISOVG32 to 68	Daphne Super Multi Oil (Idemitsu) Mobil Vactra Oil Numbered Series (Exxon Mobil) Mobil Vactra Oil No. 2 SLC (Exxon Mobil) Mobil DTE Oil Series (Exxon Mobil) Shell Tonna S3 M (Showa Shell Sekiyu) Equivalent product

- The amount of oil to be supplied varies with stroke length. For a long stroke, increase the lubrication frequency or the amount of oil applied so that an oil film is able to form along the raceway to the end of the stroke.
- In environments where liquid coolant may spatter, the lubricant may become mixed with the coolant. This could result in the lubricant being emulsified or washed away, causing significantly decreased lubrication performance. In such settings, apply a lubricant with high viscosity (kinematic viscosity: approx. 68 mm<sup>2</sup>/s) and high emulsification resistance, and adjust the lubrication frequency or the amount of feed lubricant.  
For machine tools and similar devices that are subject to heavy loads, require high rigidity, and operate at high speed, oil lubrication is recommended.
- Use only after making sure that the lubrication oil discharges normally from the ends of the lubrication piping, i.e., the oiling ports that connect to your LM system.

## Product Selection According to Usage Environment

When using the product in locations exposed to constant vibrations or under special circumstances such as in clean rooms, vacuums, and low/high temperatures, it may not be possible to use standard grease. In such cases, THK will recommend the optimal lubricant. Please contact THK for details.

Usage environment/ Conditions	Lubrication	THK product
Environments with spattering coolant	<ul style="list-style-type: none"> <li>– To stop the coolant from causing emulsification, use grease that does not easily wash away.</li> <li>– Use grease with extreme pressure and rust-proofing performance.</li> </ul> <p>Note: In environments where water-soluble coolants may spatter, there are occasions where certain types of coolant may cause emulsification or cause the grease to wash away, even if using medium-viscosity lubricant. This, in turn, may then reduce lubricity and prevent a proper oil film from forming. Check the compatibility between the lubricant and coolant.</p> <ul style="list-style-type: none"> <li>● Daphne Super Multi Oil (Idemitsu)</li> <li>● Mobil Vactra Oil No. 2 SLC (Exxon Mobil)</li> </ul>	<ul style="list-style-type: none"> <li>– Please note that applying coolant directly to THK products may have an adverse effect on components/parts made of resin, rubber, etc.</li> <li>– Consider using designs where coolant cannot come into direct contact with THK products (consider using covers or bellows).</li> <li>– Consider using some of the various dust-proofing options available in order to prevent coolant from getting inside THK products.</li> </ul>
High-temperature environment	<ul style="list-style-type: none"> <li>– Please note that the higher the temperature, the greater the risk of the grease separating and the lubrication performance dropping.</li> </ul>	<ul style="list-style-type: none"> <li>– Contact THK for a range of high-temperature specification products.</li> </ul>
Clean room	<ul style="list-style-type: none"> <li>– THK also offers a range of clean room-compatible grease products.</li> </ul> <ul style="list-style-type: none"> <li>● AFE-CA Grease (THK)</li> <li>● AFF Grease (THK)</li> <li>● L100 Grease (THK)</li> </ul>	<ul style="list-style-type: none"> <li>– Two reasons for the generation of dust are metal-to-metal contact and mutual friction between rolling elements. THK offers a range of products with a cage for minimizing metal-to-metal contact and mutual friction between the rolling elements. Furthermore, the cage is also structured in a way that maintains the lubricity, making it suitable for use in clean rooms.</li> <li>– Anti-rust oil is applied as standard, so please specify if it is not required.</li> </ul>
Vacuum environments	<ul style="list-style-type: none"> <li>– Use fluorinated lubricants for vacuums (vapor pressure varies by brand).</li> <li>– Using vacuum grease will make it more likely that the oil film will break due to its low extreme pressure resistance compared to general industrial grease. Be sure that there is a reliable feeding of oil to the raceways (by increasing the number of relubrications, etc.) in order to ensure that the oil film does not break.</li> </ul> <p>Note: If using vacuum greases, please note that some brands have starting resistances several times greater than general-purpose grease.</p>	<ul style="list-style-type: none"> <li>– Please note that under vacuum environments, there is a risk that gas given off by resin and rubber materials may cause the vacuum level to decrease.</li> <li>– Please consider using stainless steel or surface-treated products as a rust-proofing measure.</li> </ul>
High-speed moving parts	<ul style="list-style-type: none"> <li>– Use a lubricant with a low base oil kinematic viscosity to prevent heat generated by resistance from the lubricant.</li> <li>– THK offers a range of grease products with excellent high-speed specifications.</li> </ul> <ul style="list-style-type: none"> <li>● AFA Grease (THK)</li> <li>● AFG Grease (THK)</li> <li>● AFJ Grease (THK)</li> </ul>	<ul style="list-style-type: none"> <li>– Metal-to-metal contact and mutual friction between the rolling elements inside products may produce noise and quickly lead to damage.</li> <li>– THK offers a range of caged products with excellent high-speed and noise-dampening properties.</li> </ul>
Environments with water	<ul style="list-style-type: none"> <li>– Use grease with high water-proofing properties.</li> <li>– Use a lubricant with high extreme pressure resistance that does not easily wash away.</li> </ul> <ul style="list-style-type: none"> <li>● L700 Grease (THK)</li> </ul> <p>– Contact THK for instructions regarding lubricating in and around water.</p>	<ul style="list-style-type: none"> <li>– Consider using designs where water cannot come into contact with THK products. (Consider using bellows or covers.)</li> <li>– Consider using stainless steel or surface-treated products as a rust-proofing measure.</li> <li>– Consider using some of the various dust-proofing options available in order to prevent water from getting inside the product.</li> </ul>
Food machinery	<ul style="list-style-type: none"> <li>– Consider using grease that is made for food processing and that is safe for people.</li> </ul> <ul style="list-style-type: none"> <li>● L700 Grease (THK) (NSF H1 standard accredited)</li> </ul>	<ul style="list-style-type: none"> <li>– Consider using covers if there is the possibility of lubricant spattering.</li> </ul>
Micro-vibration	<ul style="list-style-type: none"> <li>– THK offers a range of grease products that work particularly well under micro-vibrations.</li> </ul> <ul style="list-style-type: none"> <li>● AFC Grease (THK)</li> <li>● AFJ Grease (THK)</li> </ul>	<ul style="list-style-type: none"> <li>– Oil films formed at the points of contact between the rolling elements and raceway are likely to break in environments with micro-vibrations.</li> <li>– By periodically overstroking, the lubricant will form an oil film at the points of contact between the rolling elements and raceway.</li> </ul>

## Lubrication Methods

There are three methods of lubricating LM systems: manual greasing using a grease gun or manual pump, forced greasing with the aid of an automatic pump, and oil-bath lubrication.

To achieve efficient lubrication, it is necessary to mount the grease nipple or the plumbing fixture according to the mounting orientation.

We also stock grease guns, grease nipples, and plumbing fixtures. See **B 24-33**.

(If using the product in any orientation other than horizontal, be sure to let THK know the mounting orientation and the exact position in each LM block where the grease nipple or the plumbing fixture should be attached. For the mounting orientation of the LM Guide, see **B 1-28**.)

---

### Manual Lubrication

---

Generally, grease is replenished periodically and fed through the grease nipple provided on the LM system using a grease gun. (Fig.1)

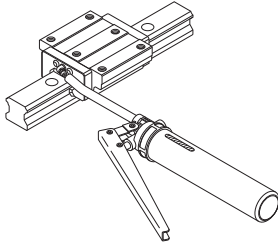

Fig.1 Lubrication using a grease gun

---

### Forced Lubrication Method

---

With this method, a given amount of lubricant is forcibly fed at a given interval. (Fig.2)

Although a special lubrication system using piping or the like needs to be designed, this method reduces the likelihood of forgetting to replenish lubricant.

Use only after making sure that the lubrication oil discharges normally from the ends of the lubrication piping, i.e., the oiling ports that connect to your LM system.

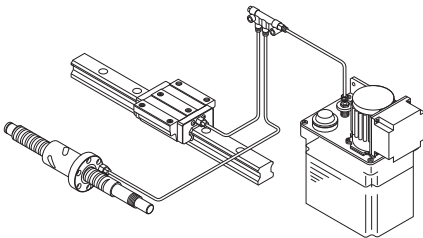

Fig.2 Forced lubrication method

# Lubrication Accessory Series for LM Systems

THK provides a wide array of lubrication accessories such as grease, grease guns, grease nipples and plumbing fixtures available for various applications. ([B24-7](#) to [B24-33](#))

## THK Original Grease

THK provides various types of THK original grease needed for the lubrication of LM systems. They are available for various conditions and environments.

[Table for Grease Selection]

Name of grease	AFA	AFB-LF	AFC	AFE-CA	AFF	AFG
Features	Low sliding friction	All-purpose type	For fretting and corrosion resistance	For clean environments	For clean environments	For preventing heat generation by ball screws
Base oil	High-grade synthetic oil	Refined mineral oil	High-grade synthetic oil	High-grade synthetic oil	High-grade synthetic oil	High-grade synthetic oil
Consistency enhancer	Urea-based	Lithium-based	Urea-based	Urea-based	Lithium-based	Urea-based
Features	Low sliding friction	○	—	—	—	○
	Micro-vibration	○	—	◎	○	○
	High load	—	○	—	—	—
	Low dust generation (Clean environments)	—	—	—	◎	—
	Water resistance	○	○	—	—	○
	Machine stability	—	○	○	○	○
Bellows cartridge color	Clear	Light green	Clear	White	Dark blue	Light green
Cap color	White	Yellow	Orange	White	White	Orange
Reference page	<a href="#">B24-7</a>	<a href="#">B24-9</a>	<a href="#">B24-11</a>	<a href="#">B24-13</a>	<a href="#">B24-15</a>	<a href="#">B24-18</a>

Name of grease	AFJ	L100	L500	L700	
Features	For a wide range of speeds	For clean environments/ High loads	For high-load ball screws	For medical, pharmaceutical, and food equipment	
Base oil	Refined mineral oil	High-grade synthetic oil	Refined mineral oil	High-grade synthetic oil	
Consistency enhancer	Urea-based	Lithium complex-based	Lithium complex-based	Calcium sulfonate complex-based	
Features	Low sliding friction	○	—	—	
	Micro-vibration	○	—	—	
	High load	○	◎	◎	○
	Low dust generation (Clean environments)	—	○	—	—
	Water resistance	—	—	—	◎
	Machine stability	○	○	○	○
Bellows cartridge color	Yellow	Blue	Purple	White	
Cap color	Blue	Yellow	Yellow	White	
Reference page	<a href="#">B24-21</a>	<a href="#">B24-25</a>	<a href="#">B24-27</a>	<a href="#">B24-29</a>	

## THK Original Grease

## AFA Grease

- Base oil: high-grade synthetic oil
- Consistency enhancer: urea-based



AFA Grease is a high-grade grease that possesses a long service life, excellent water resistance, and low sliding resistance through the use of high-grade synthetic oil as the base oil and a urea-based consistency enhancer.

**[Features]**

## (1) Low sliding resistance

As the kinematic viscosity of the base oil is low, it is ideal for long-stroke, high-speed LM Guide operations.

## (2) Water resistance

It is less vulnerable to moisture penetration than other types of grease because of its high water resistance.

**[Representative Physical Properties]**

Item	Representative value	Test method
Consistency enhancer	Urea-based	
Base oil	High-grade synthetic oil	
Base oil kinematic viscosity: mm <sup>2</sup> /s (40°C)	25	JIS K 2220 23
Worked penetration (25°C, 60 W)	285	JIS K 2220 7
Mixing stability (100,000 W)	329	JIS K 2220 15
Dropping point: °C	261	JIS K 2220 8
Evaporation amount: mass% (99°C, 22 h)	0.2	JIS K 2220 10
Oil separation rate: mass% (100°C, 24 h)	0.5	JIS K 2220 11
Copper plate corrosion (B method, 100°C, 24 h)	Accepted	JIS K 2220 9
Low-temperature torque: mN·m (-20°C)	Starting	JIS K 2220 18
	Rotational	
4-ball testing (welding load): N	3089	ASTM D2596
Service temperature range: °C	-45 to 160	
Color	Brown	

## [Sliding Resistance Comparison]

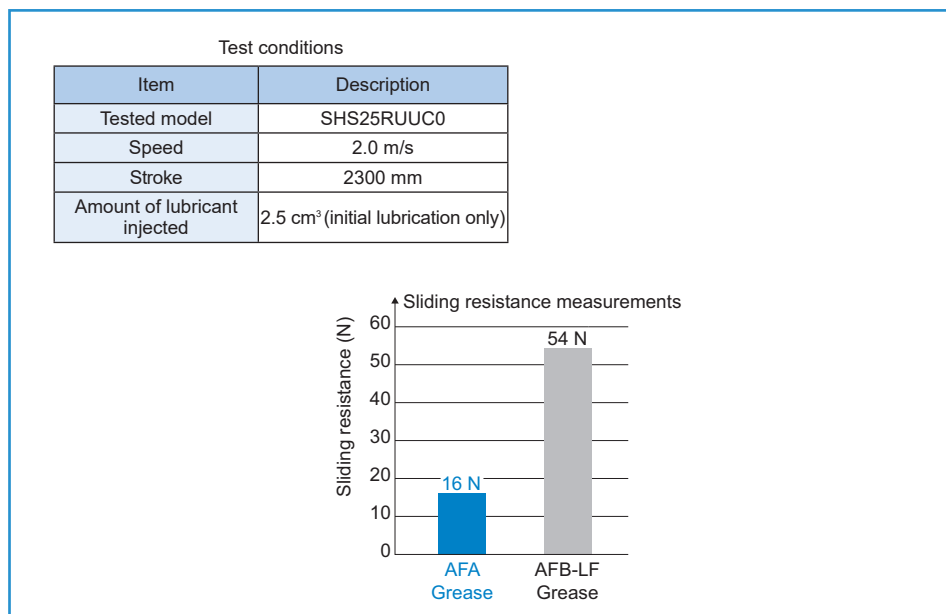

## [Rotational Torque Testing with Ball Screw Grease]

<Test method>

1 cm<sup>3</sup> of grease was applied to the KR4620A + 640L LM Guide and 2 cm<sup>3</sup> to the ball screw (initial injection only), and then the torque was measured at each motor rotation speed. The output values on the driver torque monitor were used for the torque measurements.

Rotational Torque Testing with Electric Actuators

Unit: N·cm

Grease used	Central value of dynamic viscosity mm <sup>2</sup> /s (cSt) (40°C)	Dynamic viscosity range mm <sup>2</sup> /s (cSt) (40°C)	Rotational speed			
			100 min <sup>-1</sup>	1000 min <sup>-1</sup>	2000 min <sup>-1</sup>	4000 min <sup>-1</sup>
AFA Grease	25	22.5 to 27.5	11.3	11.3	12.3	14.6
Lubricating oil VG32	32	28.8 to 35.2	11.2	10.8	13.4	14.7

## THK Original Grease

# AFB-LF Grease

- Base oil: refined mineral oil
- Consistency enhancer: lithium-based



AFB-LF Grease is a general-purpose grease that provides excellent extreme pressure performance and mechanical stability properties through the use of a refined mineral oil base oil and a lithium-based consistency enhancer.

### [Features]

#### (1) Extreme pressure resistance

The action of the special additives provides higher wear resistance and extreme pressure resistance than other lithium-based greases available on the market.

#### (2) Mechanical stability

AFB-LF Grease is not easily softened and demonstrates excellent mechanical stability even when used for a long period of time.

#### (3) Long service life

It provides many times the lubrication life of general lithium soap-based greases. As a result, it offers a lower maintenance workload and greater economy due to the longer intervals between greasing.

### [Representative Physical Properties]

Item	Representative value	Test method
Consistency enhancer	Lithium-based	
Base oil	Refined mineral oil	
Base oil kinematic viscosity: mm <sup>2</sup> /s (40°C)	170	JIS K 2220 23
Worked penetration (25°C, 60 W)	275	JIS K 2220 7
Mixing stability (100,000 W)	345	JIS K 2220 15
Dropping point: °C	193	JIS K 2220 8
Evaporation amount: mass% (99°C, 22 h)	0.4	JIS K 2220 10
Oil separation rate: mass% (100°C, 24 h)	0.6	JIS K 2220 11
Copper plate corrosion (B method, 100°C, 24 h)	Accepted	JIS K 2220 9
Low-temperature torque: mN·m (-20°C)	Starting	JIS K 2220 18
	Rotational	
4-ball testing (welding load): N	3089	ASTM D2596
Service temperature range: °C	-15 to 100	
Color	Brownish yellow	

### [Comparison of Grease Service Life Data]

Test conditions

Item	Description
Test products	HSR25CA1SS+600L
Load	9.8 kN/block
Stroke	350 mm
Speed	30 m/min (max)
Time constant	200 ms
Greasing quantity	4 cm <sup>3</sup> (initial lubrication only)

Travel distance until flaking occurs

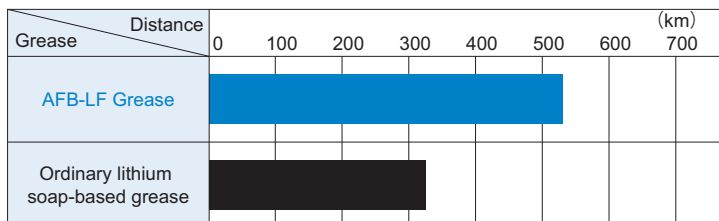

## THK Original Grease

# AFC Grease

- Base oil: high-grade synthetic oil
- Consistency enhancer: urea-based



AFC grease uses high-grade synthetic oil as its base and a urea-based grease as its consistency enhancer, while also featuring special additives. This gives it excellent fretting resistance.

### [Features]

#### (1) Fretting resistance

It is designed to be highly effective in preventing fretting corrosion.

#### (2) Wide temperature range

Since a high-grade synthetic oil is used as the base oil, the lubricating performance remains high over a wide range of temperatures, from  $-54^{\circ}\text{C}$  to  $177^{\circ}\text{C}$ .

### [Representative Physical Properties]

Item	Representative value	Test method
Consistency enhancer	Urea-based	
Base oil	High-grade synthetic oil	
Base oil kinematic viscosity: $\text{mm}^2/\text{s}$ ( $40^{\circ}\text{C}$ )	25	JIS K 2220 23
Worked penetration ( $25^{\circ}\text{C}$ , 60 W)	288	JIS K 2220 7
Mixing stability (100,000 W)	341	JIS K 2220 15
Dropping point: $^{\circ}\text{C}$	269	JIS K 2220 8
Evaporation amount: mass% ( $99^{\circ}\text{C}$ , 22 h)	0.2	JIS K 2220 10
Oil separation rate: mass% ( $100^{\circ}\text{C}$ , 24 h)	0.6	JIS K 2220 11
Copper plate corrosion (B method, $100^{\circ}\text{C}$ , 24 h)	Accepted	JIS K 2220 9
Low-temperature torque: $\text{mN}\cdot\text{m}$ ( $-20^{\circ}\text{C}$ )	Starting	JIS K 2220 18
	Rotational	
4-ball testing (welding load): N	3089	ASTM D2596
Service temperature range: $^{\circ}\text{C}$	$-54$ to $177$	
Color	Brown	

## [Fretting Resistance Test Data (Comparison of Raceway Conditions)]

Test conditions

Item	Description
Stroke	3 mm
Number of strokes per minute	200 min <sup>-1</sup>
Total number of strokes	$2.88 \times 10^5$ (24 h)
Surface pressure	1118 MPa
Grease quantity	12 cm <sup>3</sup> (replenished every 8 h)

### AFC Grease

Pre-travel

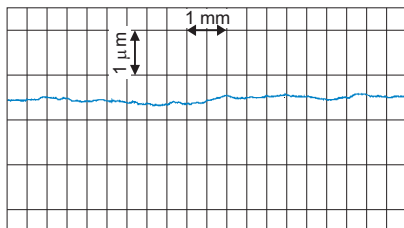

Post-travel

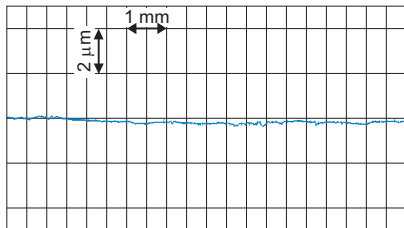

### General bearing grease

Pre-travel

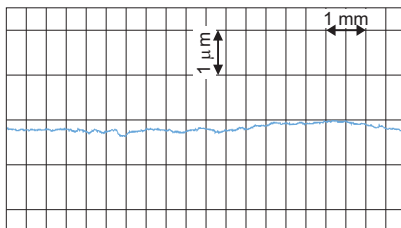

Post-travel

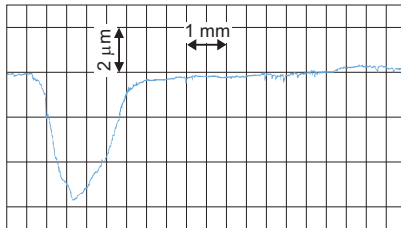

## THK Original Grease

# AFE-CA Grease

- Base oil: high-grade synthetic oil
- Consistency enhancer: urea-based



AFE-CA grease uses high-grade synthetic oil as its base and a urea-based grease as its consistency enhancer. This ensures it produces very little dust, making it ideal for use in clean environments.

### [Features]

#### (1) Low dust generation

This grease generates the least amount of dust among all THK low dust-generating grease products. Contains zero metallic elements, making it ideal for use in semiconductor-related fields.

### [Representative Physical Properties]

Item	Representative value	Test method
Consistency enhancer	Urea-based	
Base oil	High-grade synthetic oil	
Base oil kinematic viscosity: mm <sup>2</sup> /s (40°C)	99	JIS K 2220 23
Worked penetration (25°C, 60 W)	280	JIS K 2220 7
Mixing stability (100,000 W)	310	JIS K 2220 15
Dropping point: °C	260	JIS K 2220 8
Evaporation amount: mass% (99°C, 22 h)	0.1	JIS K 2220 10
Oil separation rate: mass% (100°C, 24 h)	0.1	JIS K 2220 11
Copper plate corrosion (B method, 100°C, 24 h)	Accepted	JIS K 2220 9
Low-temperature torque: mN·m (-20°C)	Starting	JIS K 2220 18
	Rotational	
4-ball testing (welding load): N	1236	ASTM D2596
Service temperature range: °C	-40 to 180	
Color	Light yellowish brown	

## [Low Dust-Generating Performance Test Data]

### ● AFE-CA Grease Test Data (Comparison of Dust Generation)

Test conditions

Item	Description
Tested model	SSR20XW1+280L
Grease quantity	1.2 cm <sup>3</sup> (initial lubrication only)
Amount of air supplied	0.3 L/min
Feeding speed	500 mm/s
Stroke	200 mm

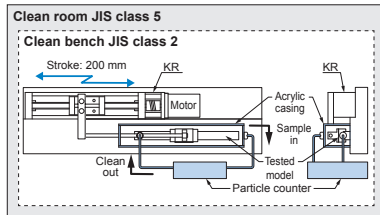

Testing device

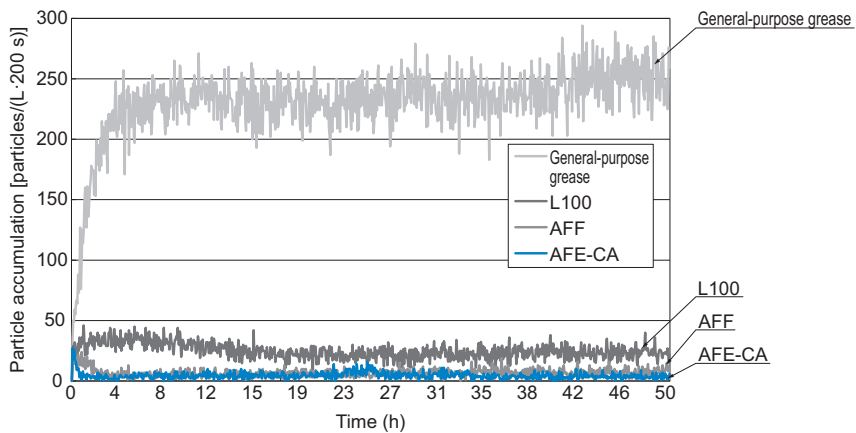

## THK Original Grease

# AFF Grease

- Base oil: high-grade synthetic oil
- Consistency enhancer: lithium-based



AFF grease uses high-grade synthetic oil as its base and a lithium-based grease as its consistency enhancer, while also featuring special additives. This gives it excellent anti-fretting and low dust-generating performance. It also features a level of stable rolling resistance not found in other conventional vacuum and low dust-generating greases.

### [Features]

#### (1) Stable rolling resistance

Since the viscous resistance is low, the rolling resistance fluctuation is also low. Thus, superb conformity is achieved at low speeds.

#### (2) Low dust generation

It generates very little dust, making it ideal for use under micro-stroke conditions.

#### (3) Fretting resistance

Since AFF grease is more resistant to wear from micro-vibrations than other low dust-generating greases, it allows the greasing interval to be extended.

### [Representative Physical Properties]

Item	Representative value	Test method
Consistency enhancer	Lithium-based	
Base oil	High-grade synthetic oil	
Base oil kinematic viscosity: mm <sup>2</sup> /s (40°C)	100	JIS K 2220 23
Worked penetration (25°C, 60 W)	315	JIS K 2220 7
Mixing stability (100,000 W)	345	JIS K 2220 15
Dropping point: °C	220	JIS K 2220 8
Evaporation amount: mass% (99°C, 22 h)	0.7	JIS K 2220 10
Oil separation rate: mass% (100°C, 24 h)	2.6	JIS K 2220 11
Copper plate corrosion (B method, 100°C, 24 h)	Accepted	JIS K 2220 9
Low-temperature torque: mN·m (-20°C)	Starting	JIS K 2220 18
	Rotational	
4-ball testing (welding load): N	1236	ASTM D2596
Service temperature range: °C	-40 to 120	
Color	Reddish brown	

## [Low Dust-Generating Performance Test Data]

### ● AFF Grease Test Data (Comparison of Dust Generation)

Test conditions

Item	Description
Tested model	SSR20XW1+280L
Grease quantity	1.2 cm <sup>3</sup> (initial lubrication only)
Amount of air supplied	0.3 L/min
Feeding speed	500 mm/s
Stroke	200 mm

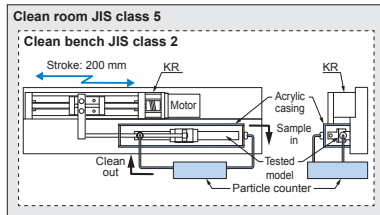

Testing device

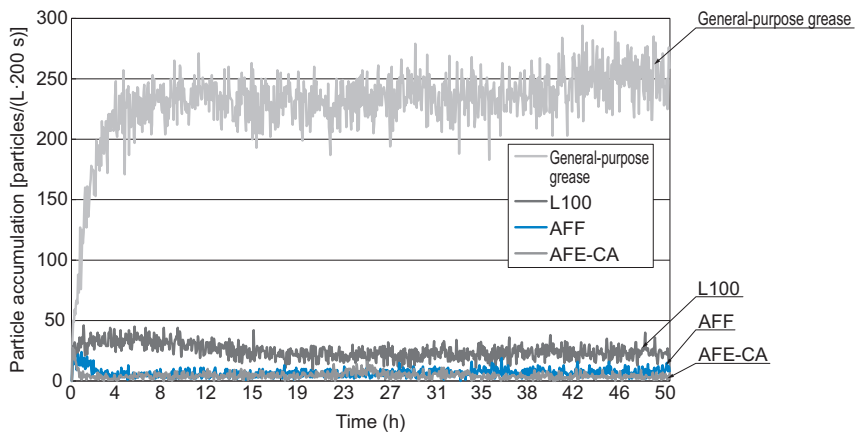

## [Rolling Resistance Characteristics at Low Speed]

Test conditions

Item	Description
Tested model	HSR35RC0+440LP
Grease quantity	4 cm <sup>3</sup> (initial lubrication only)
Feeding speed	1 mm/s
Stroke	3 mm

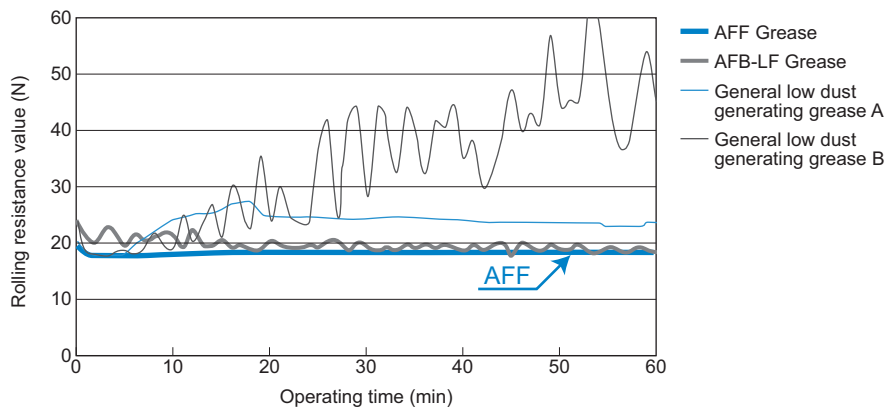

## THK Original Grease

# AFG Grease

- Base oil: high-grade synthetic oil
- Consistency enhancer: urea-based



AFG Grease is a high-grade grease for ball screws that uses high-grade synthetic oil as its base and a urea-based grease as its consistency enhancer. This ensures that it has superior low heat-generating properties, allowing for use over a wide temperature range—from low to high temperatures.

### [Features]

#### (1) Low heat generation

Since the viscous resistance is low, the grease generates only a minimal level of heat even during high-speed operation.

#### (2) Low torque properties

Features a low base oil kinematic viscosity, making it ideal for ball screws.

#### (3) Water resistance

AFG Grease is a highly water-resistant grease that is less vulnerable to softening and reductions in extreme pressure resistance due to moisture penetration.

### [Representative Physical Properties]

Item	Representative value	Test method
Consistency enhancer	Urea-based	
Base oil	High-grade synthetic oil	
Base oil kinematic viscosity: mm <sup>2</sup> /s (40°C)	25	JIS K 2220 23
Worked penetration (25°C, 60 W)	285	JIS K 2220 7
Mixing stability (100,000 W)	329	JIS K 2220 15
Dropping point: °C	261	JIS K 2220 8
Evaporation amount: mass% (99°C, 22 h)	0.2	JIS K 2220 10
Oil separation rate: mass% (100°C, 24 h)	0.5	JIS K 2220 11
Copper plate corrosion (B method, 100°C, 24 h)	Accepted	JIS K 2220 9
Low-temperature torque: mN·m (-20°C)	Starting	JIS K 2220 18
	Rotational	
4-ball testing (welding load): N	3089	ASTM D2596
Service temperature range: °C	-45 to 160	
Color	Brown	

## [Low Heat Generation Test Data]

Test conditions

Item	Description
Tested model	SBN3210-7RRG0+1094LC5 (Pre-load only)
Rotational speed	400 to 3000 min <sup>-1</sup>
Grease quantity	12 cm <sup>3</sup> (initial lubrication only)
Temperature measurement point	Nut outer diameter area

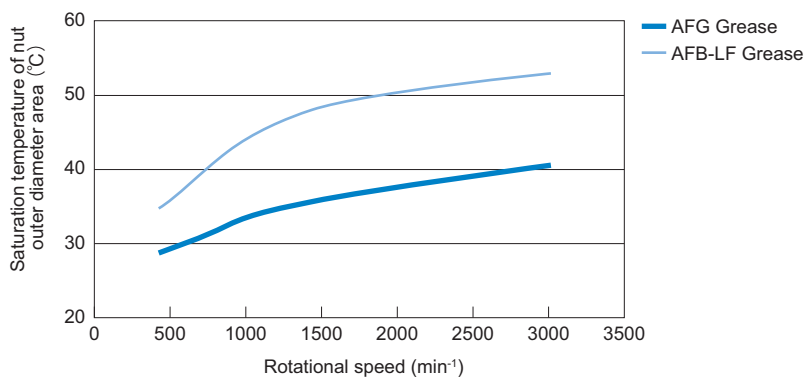

## [Ball Screw Torque Data]

Test conditions

Item	Description
Tested model	SBN3210-7RRG0+1094LC5 (Pre-load only)
Rotational speed	2 to 1200 min <sup>-1</sup>
Amount of lubricant injected	13 cm <sup>3</sup> (initial lubrication only)

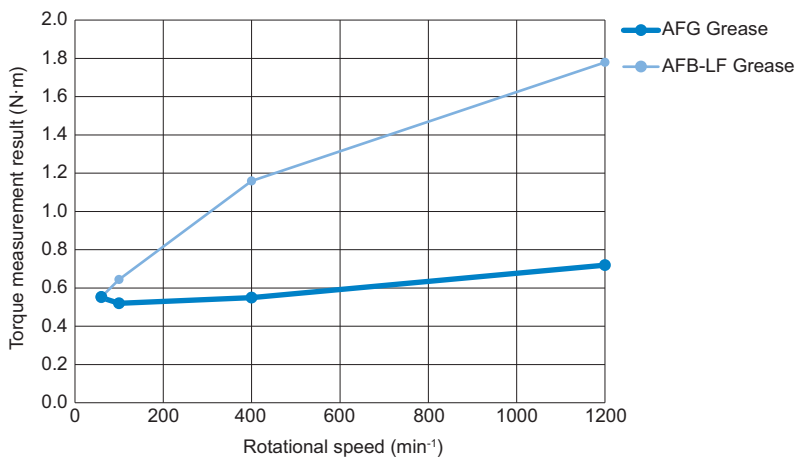

## THK Original Grease

# AFJ Grease

- Base oil: refined mineral oil
- Consistency enhancer: urea-based



AFJ grease uses refined mineral oil as its base and a urea-based grease as its consistency enhancer, while also featuring other special additives. This gives it excellent lubrication properties at a wide range of speeds—from low to high.

### [Features]

#### (1) Wide range of speeds

It provides consistent and even lubrication at a wide range of speeds, from low to high.

#### (2) Wear resistance

Even at low speeds, it has excellent oil film formation to reduce wear.

#### (3) Vibration resistance

It reduces wear caused by machine vibration during high-speed operation.

### [Representative Physical Properties]

Item	Representative value	Test method
Consistency enhancer	Urea-based	
Base oil	Refined mineral oil	
Base oil kinematic viscosity: mm <sup>2</sup> /s (40°C)	20	JIS K 2220 23
Worked penetration (25°C, 60 W)	325	JIS K 2220 7
Mixing stability (100,000 W)	360	JIS K 2220 15
Dropping point: °C	185	JIS K 2220 8
Evaporation amount: mass% (99°C, 22 h)	0.6	JIS K 2220 10
Oil separation rate: mass% (100°C, 24 h)	7.0	JIS K 2220 11
Copper plate corrosion (B method, 100°C, 24 h)	Accepted	JIS K 2220 9
Low-temperature torque: mN·m (-20°C)	Starting	JIS K 2220 18
	Rotational	
4-ball testing (welding load): N	3089	ASTM D2596
Service temperature range: °C	-20 to 120	
Color	Yellowish brown	

## [Wear Resistance Test Data (LM Guide Block)]

Test conditions

Item	Description
Tested model	NRS55B2SS+780LP
Applied load	5.9 kN
Feeding speed	0.1 m/min
Stroke	200 mm
Grease quantity	12 cm <sup>3</sup> (initial lubrication only)
Test duration	480 h

### AFJ Grease

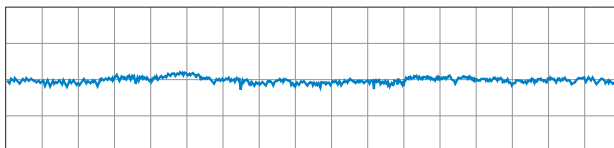

### Other urea-based grease

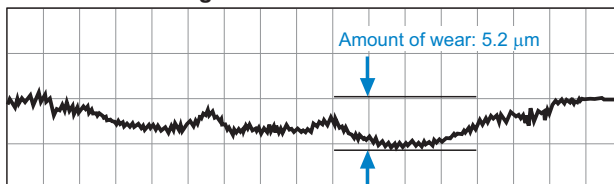

## [Vibration Resistance Test Data (LM Guide Rail)]

Test conditions

Item	Description
Tested model	SHS25R1UU+580LP
Applied load	11.05 kN (0.35C)
Feeding speed	60 m/min
Acceleration/ deceleration	9.8 m/s <sup>2</sup>
Stroke	350 mm
Grease quantity	2 cm <sup>3</sup> (initial lubrication only)

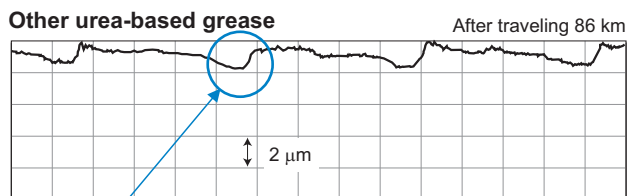
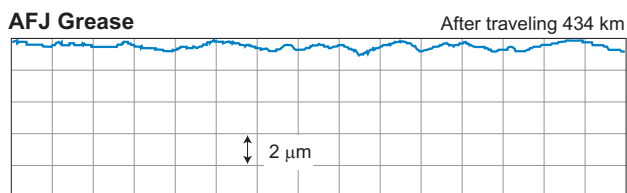

**“Wear  
mechanism”**

High-speed  
movement and  
rapid acceleration/  
deceleration

Mechanical  
vibrations  
occur

Raceways  
wear down

## [LM Guide Rolling Resistance Measurement Data]

Test conditions

Item	Description
Tested model	SHS25R1UU+3000L
Applied load	No load
Acceleration	29.4 m/s <sup>2</sup> (3G)
Stroke	2300 mm
Test temperature	21°C
Grease quantity	2 cm <sup>3</sup> (initial lubrication only)
Measurement speed	0.5, 1, 2, 3, 4, 5, 6 m/s

### LM Guide speed and rolling resistance

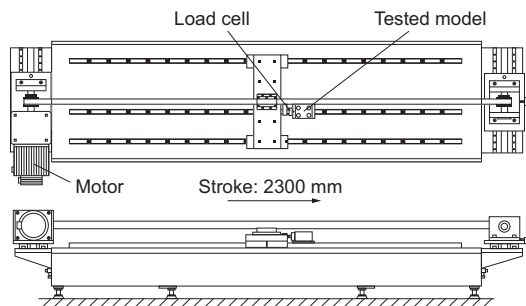
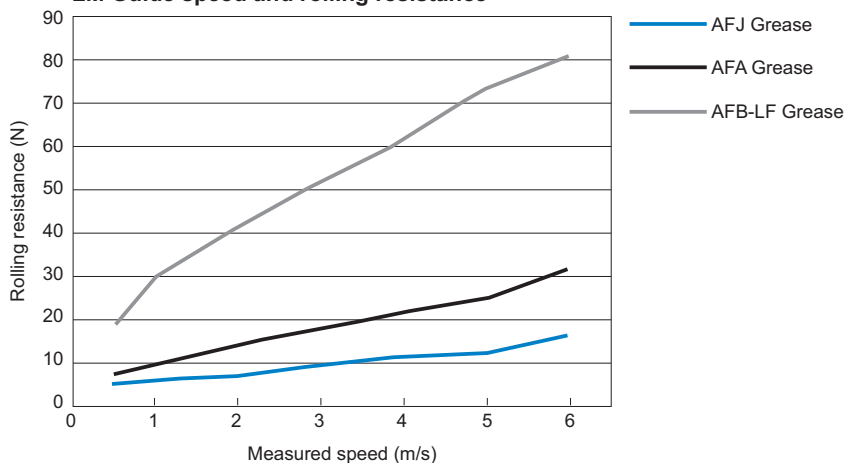

## THK Original Grease

# L100 Grease

- Base oil: high-grade synthetic oil
- Consistency enhancer: lithium complex-based



L100 grease uses high-grade synthetic oil as its base and lithium complex-based grease as its consistency enhancer, while also featuring special additives. It also produces little dust and boasts excellent extreme pressure resistance to a degree not found in standard low dust-generating greases. This makes it ideal for use in clean rooms.

Note: This product cannot be used in Europe.

### [Features]

#### (1) Low dust generation

It demonstrates the same low dust-generating performance as our previous low dust-generating grease, making it ideal for use in clean rooms.

#### (2) Extreme pressure resistance

The action of the additives and base oil (which is suitable for withstanding loads) gives it extreme pressure resistance three times greater than our previous low dust-generating grease.

### [Representative Physical Properties]

Item	Representative value	Test method
Consistency enhancer	Lithium complex-based	
Base oil	High-grade synthetic oil	
Base oil kinematic viscosity: mm <sup>2</sup> /s (40°C)	198	JIS K 2220 23
Worked penetration (25°C, 60 W)	294	JIS K 2220 7
Mixing stability (100,000 W)	312	JIS K 2220 15
Dropping point: °C	260	JIS K 2220 8
Evaporation amount: mass% (99°C, 22 h)	0.1	JIS K 2220 10
Oil separation rate: mass% (100°C, 24 h)	0.8	JIS K 2220 11
Copper plate corrosion (B method, 100°C, 24 h)	Accepted	JIS K 2220 9
Low-temperature torque: mN·m (-20°C)	Starting	JIS K 2220 18
	Rotational	
4-ball testing (welding load): N	3922	ASTM D2596
Service temperature range: °C	-40 to 150	
Color	Yellow	

## [Low Dust-Generating Performance Test Data]

### ● Comparison with other THK greases

Test conditions

Item	Description
Tested model	SSR20XW1
Grease quantity	1.2 cm <sup>3</sup> (initial lubrication only)
Amount of air supplied	0.3 L/min
Feeding speed	500 mm/s
Stroke	200 mm

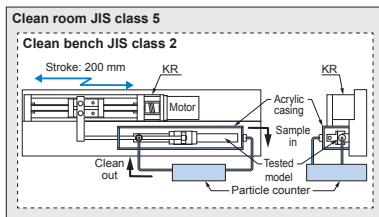

Testing device

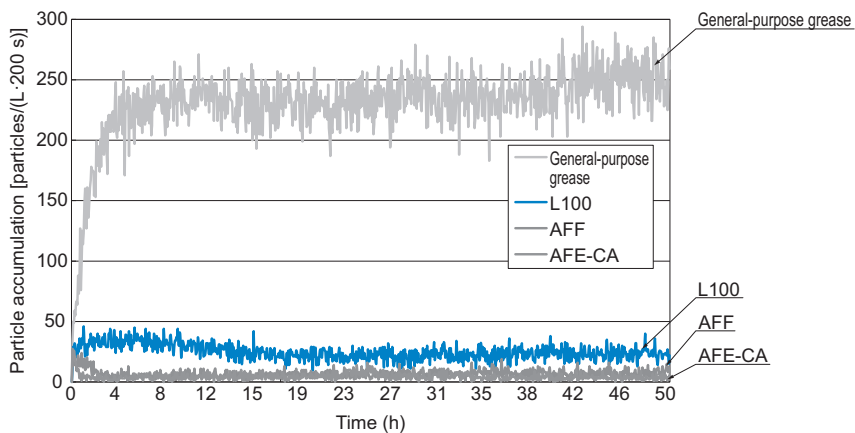

## [Extreme Pressure Resistance]

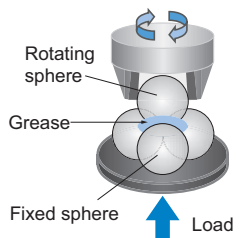

Testing apparatus

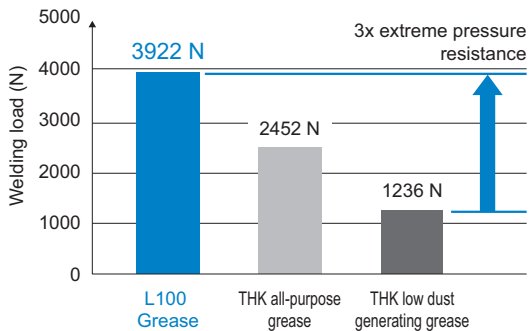

## THK Original Grease

# L500 Grease

- Base oil: refined mineral oil
- Consistency enhancer: lithium complex-based



L500 grease uses refined mineral oil as its base and lithium complex-based grease as its consistency enhancer, while also featuring special additives. It features excellent extreme pressure resistance and pumpability as well as a long service life.

Note: This product cannot be used in Europe.

### [Features]

#### (1) Extreme pressure resistance

The action of the special additives gives it excellent extreme pressure resistance.

#### (2) Long service life

It provides longer lasting lubrication than general high-load grease, helping reduce the amount of time spent on maintenance.

#### (3) Pumpability

It boasts excellent pumpability, allowing it to be used with automatic lubricating systems.

### [Representative Physical Properties]

Item	Representative value	Test method
Consistency enhancer	Lithium complex-based	
Base oil	Refined mineral oil	
Base oil kinematic viscosity: mm <sup>2</sup> /s (40°C)	120	JIS K 2220 23
Worked penetration (25°C, 60 W)	327	JIS K 2220 7
Mixing stability (100,000 W)	365	JIS K 2220 15
Dropping point: °C	250	JIS K 2220 8
Evaporation amount: mass% (99°C, 22 h)	0.4	JIS K 2220 10
Oil separation rate: mass% (100°C, 24 h)	2.5	JIS K 2220 11
Copper plate corrosion (B method, 100°C, 24 h)	Accepted	JIS K 2220 9
Low-temperature torque: mN·m (-20°C)	Starting	JIS K 2220 18
	Rotational	
4-ball testing (welding load): N	4903	ASTM D2596
Service temperature range: °C	-20 to 175	
Color	Yellow	

### [Extreme Pressure Resistance]

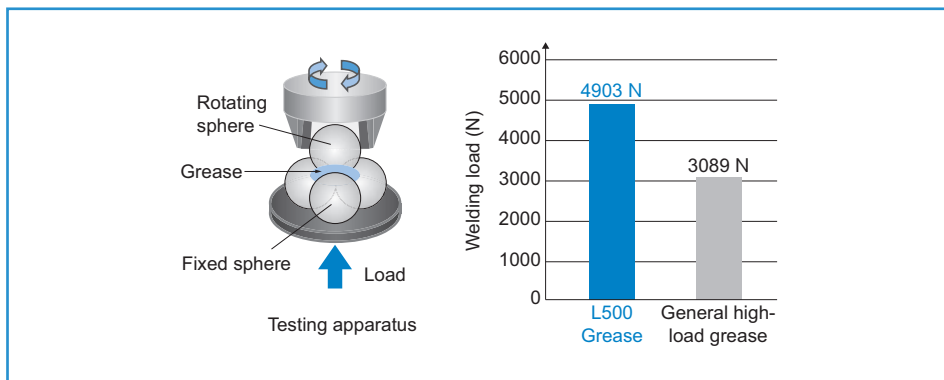

### [Long Service Life]

#### ● Lubrication service life measured via ball screw

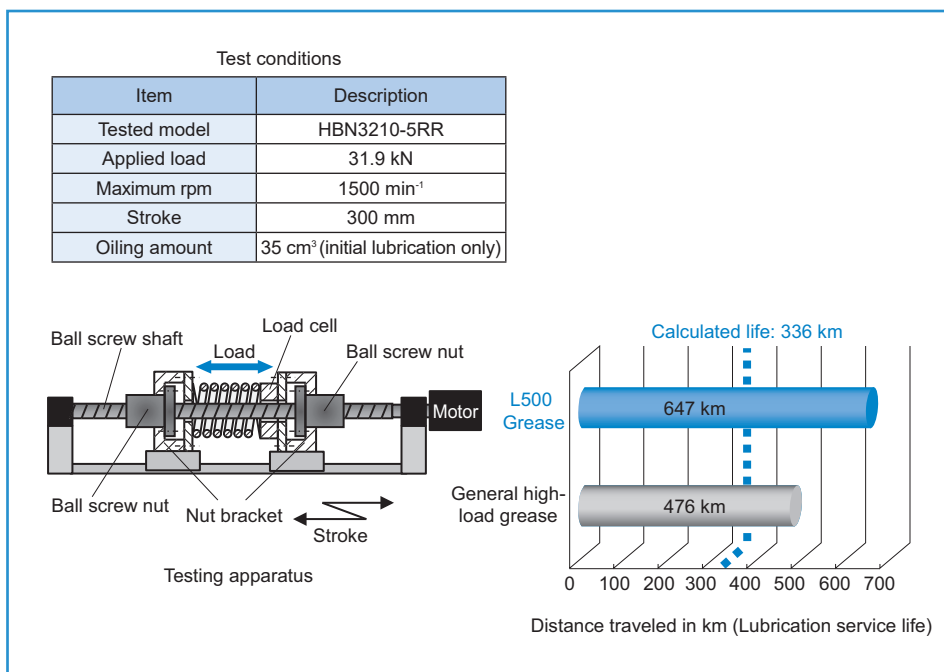

## THK Original Grease

# L700 Grease

- Base oil: high-grade synthetic oil
- Consistency enhancer: calcium sulfonate complex-based



L700 Grease is an H1 grease product certified and registered by NSF International.<sup>1</sup> Using a high-grade synthetic oil as the base oil in conjunction with a calcium sulfonate complex-based consistency enhancer, L700 Grease maintains excellent water and corrosion resistance and withstands extreme pressure. It is intended for use in medical, pharmaceutical, and food equipment.

<sup>1</sup> A third party certification body for matters related to public safety and health

Note: This product cannot be used in Europe.

### [Features]

#### (1) NSF-certified

L700 Grease is an H1 grease product certified and registered by NSF International (NSF H1).

#### (2) Water and corrosion resistance

Calcium sulfonate (the consistency enhancer) makes L700 Grease more resistant to water and corrosion than ordinary H1 grease.

#### (3) Extreme pressure resistance

L700 Grease displays better extreme pressure resistance than general-purpose grease.

### [Representative Physical Properties]

Item	Representative value	Test method
Consistency enhancer	Calcium sulfonate complex-based	
Base oil	High-grade synthetic oil	
Base oil kinematic viscosity: mm <sup>2</sup> /s (40°C)	89	JIS K 2220 23
Worked penetration (25°C, 60 W)	314	JIS K 2220 7
Mixing stability (100,000 W)	324	JIS K 2220 15
Dropping point: °C	250	JIS K 2220 8
Evaporation amount: mass% (99°C, 22 h)	0.15	JIS K 2220 10
Oil separation rate: mass% (100°C, 24 h)	2.9	JIS K 2220 11
Copper plate corrosion (B method, 100°C, 24 h)	Accepted	JIS K 2220 9
Low-temperature torque: mN·m (-20°C)	Starting	JIS K 2220 18
	Rotational	
4-ball testing (welding load): N	3922	ASTM D2596
Service temperature range: °C	-40 to 200	
Color	Tan	

**[Water Resistance]**

- Leakage comparison with ordinary H1 grease by rotating a bearing containing grease mixed with 10 mass% of water

## Test conditions

Item	Description
Bearing	JIS B 1521 6204, Open type, Class 0, C3 clearance
Water content	10% of the grease weight
Rpm	600 min <sup>-1</sup>
Test duration	60 min

## Test result



L700 Grease



Ordinary H1 grease

**[Low Sliding Resistance]**

- Measurement of sliding resistance when an LM Guide is injected with grease and operated at low speed to high speed

Test conditions

Item	Description
Tested model	SHS25
Measurement speed	0.1 to 3.0 m/s
Acceleration	29.4 m/s <sup>2</sup> (3G)
Stroke	2300 mm

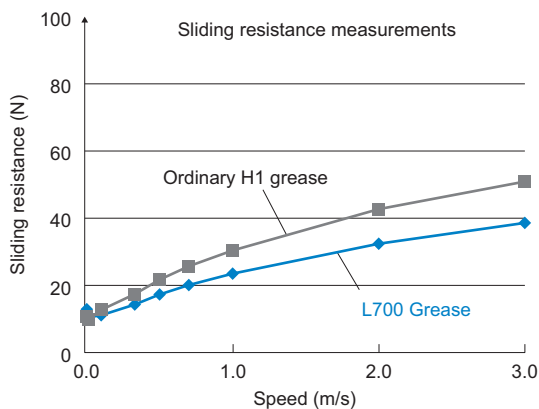
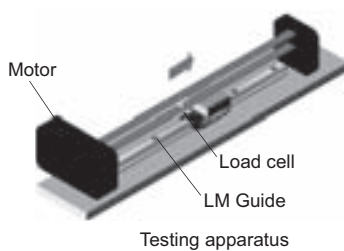

### [Extreme Pressure Resistance]

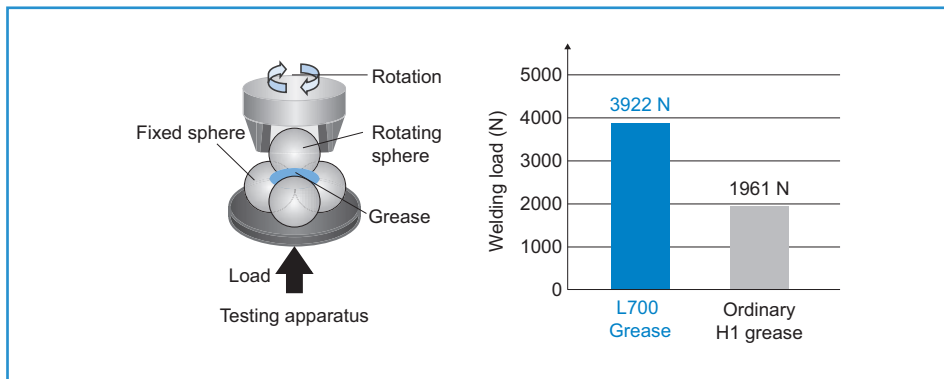

### [Low-Temperature Characteristics]

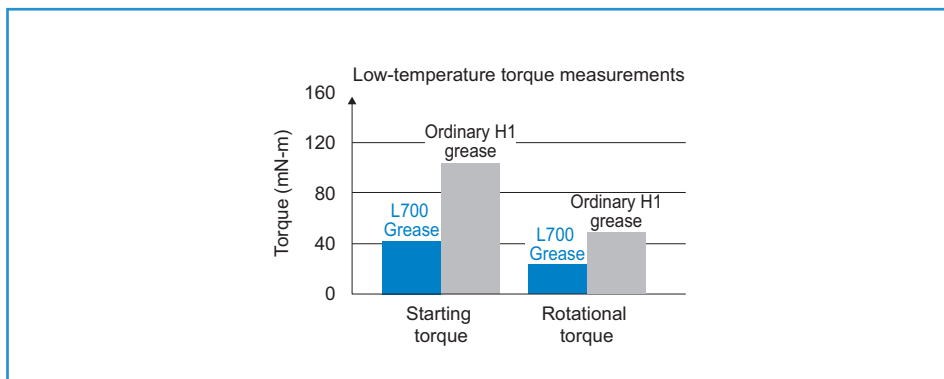

## Lubrication Equipment

# Grease Gun Unit MG70

● For detailed dimensions, see [B24-33](#).



The MG70 grease gun unit is designed especially for use with 70 g and 80 g bellows cartridges. It allows the user to grease the insides of products without dirtying their hands.

The grease gun features a slit window, allowing the user to check the remaining amount of grease.

## Accessories for Lubrication

# Special Plumbing Fixtures

● For detailed dimensions, see [B24-34](#).

We offer a range of special plumbing fixtures that are required for centralized greasing and oil lubrication.

## Accessories for Lubrication

# Grease Nipple

● For detailed dimensions, see [B24-35](#).

We offer various types of grease nipples required for the lubrication of various THK products.

## Grease Volume by Product

Name of grease	L100	L500	L700	AFA	AFB-LF	AFC	AFE-CA	AFF	AFG	AFJ
Volume by product*	80 g 400 g 16 kg	80 g 400 g 16 kg	80 g 400 g	70 g 400 g 16 kg	70 g 400 g 16 kg	70 g 400 g 16 kg	70 g 400 g 18 kg	70 g 400 g 16 kg	70 g 400 g 16 kg	70 g 400 g 16 kg

\*The 70 g, 80 g, and 400 g types come in bellows cartridges. The 16 kg and 18 kg types come in 18-liter cans.

### Model number coding

- L100, L500, and L700 Grease

**L100 GREASE + 80G**

|
|
 Cartridge capacity (80 g/400 g/16 kg)  
 Type of grease (L100, L500, or L700)

- AFA, AFB-LF, AFC, AFE-CA, AFF, AFG, and AFJ Grease

**AFC + 70G**

|
|
 Cartridge capacity (70 g/400 g/16 kg/18 kg)  
 Type of grease (AFA, AFB-LF, AFC, AFE-CA, AFF, AFG, or AFJ)

# Glossary

Term	Description																		
Base oil	Base oil is the base ingredient of lubricating oil and grease. It is the component that determines features such as the viscosity of the lubricant. Mineral oil obtained by refining crude oil includes paraffin-based and naphthene-based oils. Synthetic oils obtained by chemical synthesis can also be used as the base ingredient of synthetic lubricants.																		
Consistency enhancer	Consistency enhancers are used to turn base oils semi-solid. They can be broadly split into two types, namely soap-based types and non-soap-based types. (1) Soap-based types: Calcium, sodium, or lithium salts from high-grade fatty acids—the main components of animal fats and oils—are the most commonly used consistency enhancers. There are also some that use complex soaps as consistency enhancers. (2) Non-soap-based types: For greases that require heat resistance, there are types that use inorganic matter such as bentone or silica gel as the main component, and types that use organic matter with heat-resistant properties such as urea compounds and fluorine compounds. These tend to be used more than soap-based types in high operating temperatures, as they contain no metallic elements and will not oxidize metal parts.																		
Additives	Additives are used for improving special functions required of the grease. These can be added, as required, in the same way as general-use lubricants, and they include antioxidants, rust-proofing agents, extreme pressure agents, oiling agents, structural stability agents, and solid lubricants.																		
Lithium soap-based grease (Soap-based grease)	Lithium soap-based grease is a general-purpose grease used for the widest range of products and applications. It is used in general industries, automobiles, various types of bearings, and home appliances. Using mineral oil or synthetic oil in conjunction with a lithium soap with hydrogenated fatty acid-derived castor oil or lithium stearate as a consistency enhancer allows for use over a wide temperature range and provides excellent water resistance and shear stability properties.																		
Lithium complex grease (Soap-based grease)	Lithium complex grease uses soap such as that made by reacting fatty acids and dibasic acid with lithium hydroxide as a consistency enhancer. This gives a dropping point of at least 260°C, and excellent heat, water, and corrosion resistance. It can be used under higher temperatures than lithium grease.																		
Urea grease (Non-soap-based grease)	Urea grease is a grease containing organic compounds with two or more urea groups (-NH-CO-NH-) that is generally used as a consistency enhancer. Its excellent heat and water resistance allows it to be used in everything from rolling mills to continuous casting equipment for steel manufacturers. Urea grease is a common non-soap-based grease. It is also widely used in automobiles and electrical components.																		
Base oil kinematic viscosity (JIS K 2220 23)	The base oil kinematic viscosity represents the viscosity of the base oil. Its value is derived from measuring the magnitude of the internal resistance of the base oil. The higher the base oil kinematic viscosity, the higher the viscosity level. The smaller the value, the lower the viscosity level. For lubricating oils, the SI units are expressed in terms of mm <sup>2</sup> /s (40°C) = cSt. cSt (=1 × 10 <sup>-6</sup> m <sup>2</sup> /s) is also generally used.																		
Worked penetration (JIS K 2220 7)	The worked penetration represents the hardness of the grease. The higher the worked penetration value, the more pliable the grease. The lower the value, the harder the grease. This consistency level is obtained directly after keeping the grease at 25°C with a regulated mixer and then mixing it back and forth 60 times. NLGI <sup>1</sup> consistency numbers are classified according to the worked penetration value. <sup>1</sup> NLGI: National Lubricating Grease Institute NLGI No. and Worked Penetration Value <table border="1"> <thead> <tr> <th>NLGI No.</th> <th>Worked penetration</th> <th>Status</th> </tr> </thead> <tbody> <tr> <td>No.00</td> <td>400 to 430</td> <td>Semi-fluid state</td> </tr> <tr> <td>No.0</td> <td>355 to 385</td> <td>Extremely pliable</td> </tr> <tr> <td>No.1</td> <td>310 to 340</td> <td>Pliable</td> </tr> <tr> <td>No.2</td> <td>265 to 295</td> <td>Moderate</td> </tr> <tr> <td>No.3</td> <td>220 to 250</td> <td>Slightly hard</td> </tr> </tbody> </table>	NLGI No.	Worked penetration	Status	No.00	400 to 430	Semi-fluid state	No.0	355 to 385	Extremely pliable	No.1	310 to 340	Pliable	No.2	265 to 295	Moderate	No.3	220 to 250	Slightly hard
NLGI No.	Worked penetration	Status																	
No.00	400 to 430	Semi-fluid state																	
No.0	355 to 385	Extremely pliable																	
No.1	310 to 340	Pliable																	
No.2	265 to 295	Moderate																	
No.3	220 to 250	Slightly hard																	
Mixing stability (JIS K 2220 15)	Mixing stability represents the mechanical stability of grease. This consistency is obtained by working the grease 100,000 times with a regulated mixer, keeping it at 25°C, and then mixing another 60 times.																		

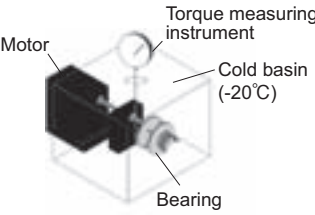
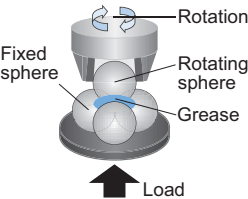
Term	Description
Dropping point (JIS K 2220 8)	The dropping point represents the temperature at which grease melts and begins to flow. (It is not the operating temperature limit.) It serves as a guide for heat resistance.
Evaporation amount (JIS K 2220 10)	The evaporation amount represents the volume of oil in the grease lost to evaporation when the grease is exposed to high temperatures. If there is a high volume of oil lost to evaporation when used under high-temperature conditions, the grease becomes more likely to harden and thus may become ineffective as a lubricant. The evaporation amount is calculated by leaving the grease in a bath at a specified temperature (99°C) for 22 hours and then comparing the volume both before and after the test.
Oil separation rate (JIS K 2220 11)	The oil separation rate represents the level of oil floating on the surface of the grease when the grease is left for a long period. When heat and force (gravity, pressure, and centrifugal forces) act upon grease, the consistency enhancer becomes unable to hold the base oil and partially separates from it. This phenomenon is called oil separation. High levels of separation impact the life of mechanical components due to depletion of the lubricant.
Copper plate corrosion (JIS K 2220 9)	Copper plate corrosion is determined by immersing a copper plate in grease, and then checking whether the copper plate changes color or not after it is left at a specified temperature for a set length of time. It is mainly a guide for determining the presence of corrosive sulfur.
Low-temperature torque (JIS K 2220 18)	<p>Low-temperature torque represents the increased torque of bearings when grease becomes hard in low temperatures. The starting and rotational torque of bearings are measured in low-temperature baths; the lower the value, the greater the fluidity in low temperatures.</p> 
4-ball testing (Welding load) (ASTM D2596)	<p>4-ball testing (welding load) indicates the level of load-bearing capacity for grease. Four steel balls with the same dimensions are used to build a pyramid shape, the bottom three balls are fixed together and immersed in the sample solution, and the top ball is pressed down and rotated.</p> 
Viscosity index	The viscosity index represents the relationship between the viscosity and temperature of grease. The greater the value, the less change in viscosity due to temperature.
Oxidation stability	The oxidation stability indicates the levels of oxidative degradation when grease reacts with oxygen in the air. The oxidation causes the grease to become more likely to liquefy as the consistency enhancer becomes unable to maintain the base oil. It also causes increased viscosity of the base oil and the generation of corrosive substances, etc. The value is obtained by heating the grease to 99°C within a cylinder at an oxygen pressure of 0.755 MPa, recording the pressure drops at set intervals, and then measuring how much the pressure has decreased after 100 hours.